

AIR TYPE CIRCUIT BREAKERS



Air Type Circuit Breakers (ACB)



F121E / F122E / F123E
630A ... 2000A



F131E / F132E / F133E
2500A ... 3200A



F141E / F142E / F143E
4000A



F151E / F152E / F153E
5000A - 6300A

IEC / EN 60947-2
CE

Mounting Position : Vertical
Altitude : 2000 m (max)
Relative Humidity : %90 (55°C)
Ambient Temperature : between -25°C and +60°C
Pollution Degree : III
Protection Degree : IP40 (at assembly lever area)

AIR TYPE CIRCUIT BREAKERS

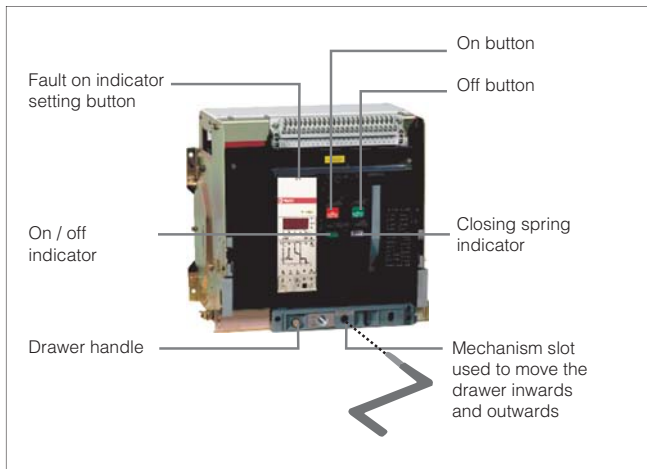

Air type circuit breakers are used for protection of generators with large powers, motor, capacitor groups and transformers, as well as general protection of factories, shopping malls, business centers.

Drawout Type Circuit Breaker:

Circuit breakers are automatically turned on during pull and push of the drawer via lever. When drawer-type switches fail, they can be quickly replaced with the spare one.

Features of Control Circuit

Protection Functions:

Various functions such as overload, long reverse time delayed, short reverse time delayed, short time delayed, fixed time curves are available for users demanding various protection features.

Indicator Function:

There is current adjustment indicator and operating current indicator.

Ammeter Function:

It shows the current passing through the circuit.

Alarm Feature:

It shows overload status.

Self-Control Feature:

It separates itself from the system with protection and control units against overheating.

Test Feature:

It is used to test features of the breaker.

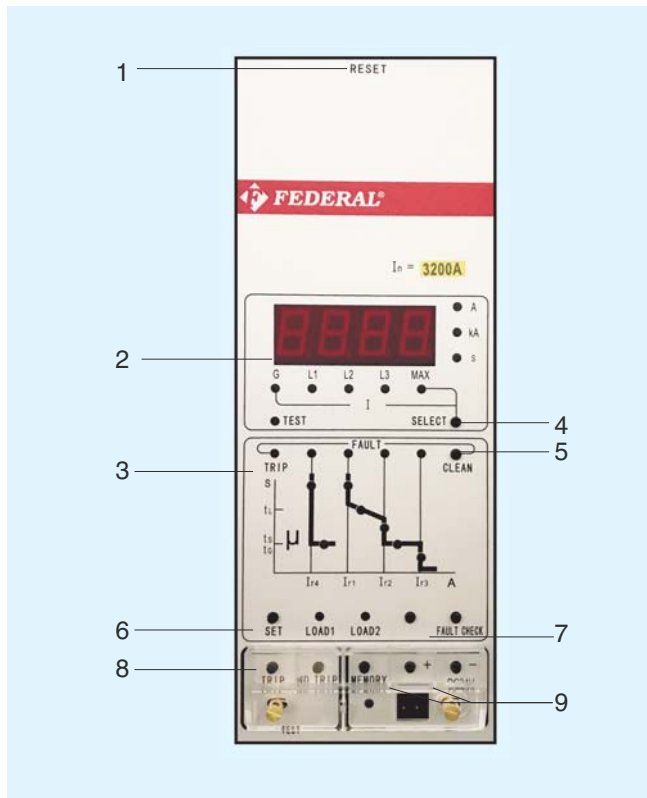
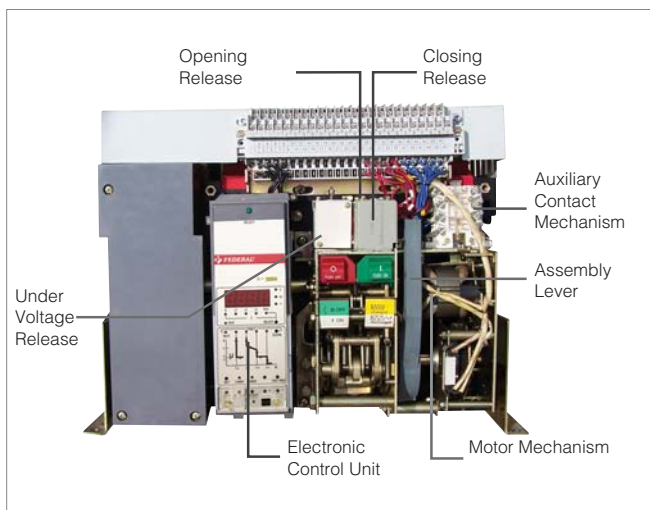

Functions of buttons:

1- RESET: Press reset button after breaker trips, the breaker will get ready to close again.

2- CURRENT-TIME indicator: It shows the current and opening time.

3- LED: It shows status and features of the breaker.

4- SELECT: It shows maximum phase current under normal conditions. Current of each phase is displayed when you press this button.

5- CLEAN: Reset button must be pressed to close the breaker after adjusting operating current or opening breaker fault current.

6- SET: You may press this button to adjust and check current and time characteristics and each status may be displayed in order.

7- FAULT CHECK: When you press this button, the last fault status, faulty current and time is displayed.

8- TRIP and NON-TRIP: Only for test.

9- MEMORY: Features adjusted with (+) and (-) buttons are saved.

AIR TYPE CIRCUIT BREAKERS

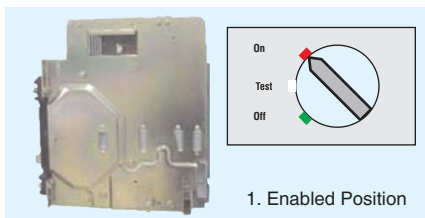

1. Enabled Position

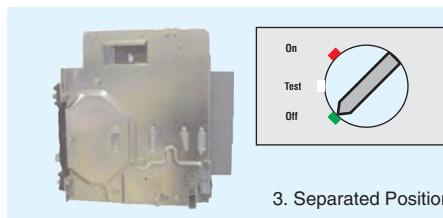

3. Separated Position

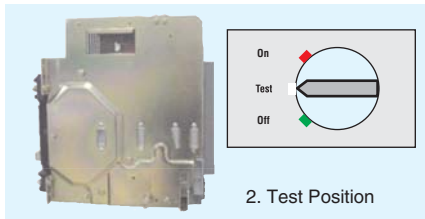

2. Test Position

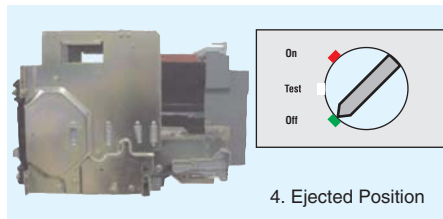

4. Ejected Position

Air type circuit breaker may be in four positions on the drawer:

- 1. Enabled Position:** All the power circuits and auxiliary contacts are enabled.
- 2. Test Position:** Power circuits are separated, but auxiliary contacts are enabled. This is the position of testing.
- 3. Separated Position:** All the power circuits and auxiliary contacts are separated.
- 4. Ejected Position:** All the power circuits and auxiliary contacts are separated. This is the position of ejecting the breaker from its drawer.

Protection Features of Over Current Breaker:

Adjustment values of the breaker are given in the table below.

Long delay		Short delay		Instantaneous		Ground fault	
I_{r1}	Accuracy	I_{r2}	Accuracy	I_{r3}	Accuracy	I_{r4}	Accuracy
$(0.4-1) \times I_n$	$\pm 10\%$	$(0.4-15) \times I_n$	$\pm 10\%$	$1.0 \times I_n - 50kA$	$\pm 15\%$	$(0.2-0.8) \times I_n$	$\pm 10\%$

Opening Time Features:

Over current protection, long time delay, reverse time opening features are given in the table below.

1,05xL	1,3xL	1,5xL	time setting (s)	15	30	60	120	240	480
>2h non tripping	<1h tripping	2,0xL	action time (s)	8.4	16.9	33.7	67.5	135	270



Assembly of Federal air type circuit breakers should be made in vertical position only.

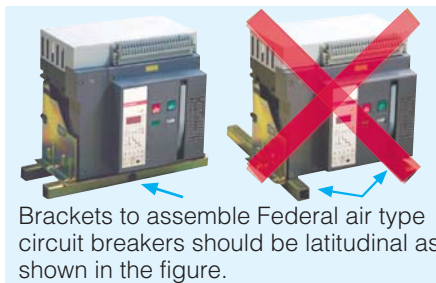

Brackets to assemble Federal air type circuit breakers should be latitudinal as shown in the figure.

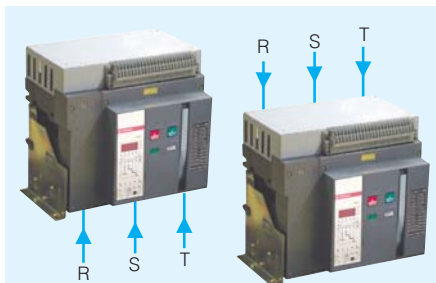

Energy connection of Federal air type circuit breakers can be made at both bottom and top connection terminals.

Short time delay over current protection, opening features:

Reverse time (in short time delay current) protection feature of the breaker.

$$I^2t = (8 \times I_{r1})^2 \times t_s$$

T: Opening time of the breaker

I: Fault current (Opening current)

t_s: Adjusted short delay time

Ir1: If the adjusted long delay opening current is higher than over current $8 I_{r1}$, the opening time (t_s) shall automatically turn into the adjusted delay time.

Ammeter Feature:

The ammeter shows the main circuit current on display screen. When SELECT button is pressed, it shows current of the phase with LED on or maximum phase current. When the button is pressed again, current of the other phase is shown.

Test Feature:

The breaker test be performed by pressing the test button. There are two kind of test buttons. One of them is non-trip test button and the other is trip test button. Non-trip test is performed when the breaker is connected to the network. Test is automatically broken when there is over current on the network.

Adjustment Feature:

Current and delay times are adjusted by pressing "+/-" buttons according to user needs. When you see the required current or delay time on the display, save it by pressing Storage button. When over

current is present, this function is broken automatically.

Load-Dependent Features: Two values can be set:

Load 1 current (I_{c1}) adjustment range $(0.2-1) \times I_n$ and Load 2 current (I_{c2}) adjustment range $(0.2-1) \times I_n$, I_{c1} time delay is adjusted to half of long time delay.

I_{c2} time delay has two features; first one is reverse time delay adjusted to $\frac{1}{2}$ of long time delay and second one is fixed time delay set to 60 sec. I_{c1} and I_{c2} current values are used for disabling and enabling insignificant loads.

AIR TYPE CIRCUIT BREAKERS

Type (LSIG)	F121E F122E F123E			F131E F132E F133E			F141E F142E F143E			F151E F152E F153E		
	F121E	F122E	F123E	F131E	F132E	F133E	F141E	F142E	F143E	F151E	F152E	F153E
Rated current - In	A 630,800,1000 1250,1600,2000			2500, 3200			4000*			5000, 6300		
Number of poles	3 / 4			3 / 4			3 / 4			3 / 4		
Rated operating voltage - Ue (a.c.) 50-60 Hz	V 415			415			415			415		
Rated insulation voltage - Ui (a.c.) 50-60 Hz	V 1000 V			1000 V			1000 V			1000 V		
Rated impulse withstand voltage - Uimp	kV 8			8			8			8		
Test voltage (1 min) (a.c.) 50-60 Hz	kV 3			3			3			3		
Rated Current Adjustment field	In (0,4-1)In			(0,4-1)In			(0,4-1)In			(0,4-1)In		
Rated ultimate short circuit breaking capacity - Icu 415V~ (kA rms)	70	80	100	70	80	100	70	80	100	70	80	120
Rated service short circuit breaking capacity - Ics 415V~ (kA rms)	35	50	65	35	65	80	35	65	80	35	65	100
Rated short time withstand capacity - Icw 1s 415 V~ (kA rms)	35	50	65	35	65	80	50	65	80	50	65	100
Category (EN 60947-2 / IEC 60947-2)	A, B			A, B			A, B			A, B		
Opening type	Electronic			Electronic			Electronic			Electronic		
Assembly method	Fixed / Drawout			Fixed / Drawout			Fixed / Drawout			Drawout		
Long time delay current (L)	Ir1 (0,4-1)In			(0,4-1)In			(0,4-1)In			(0,4-1)In		
Long time delay interval	tl s 15-500			15-500			15-500			15-500		
Short time delay current (Is)	Ir2 (0,4-15)In			(0,4-15)In			(0,4-15)In			(0,4-15)In		
Short time delay interval	ts s 0,1 - 1			0,1 - 1			0,1 - 1			0,1 - 1		
Instantaneous breaking current (Ii)	Ir3 In-50 kA			In-50 kA			In-50 kA			In-50 kA		
Ground fault current (Ig)	Ir4 (0,2-0,8)In			(0,2-0,8)In			(0,2-0,8)In			(0,2-0,8)In		
Mechanical life	With maintenance 10000			10000			10000			10000		
	Without maintenance 3000			3000			3000			3000		
Power losses per pole	Drawout 38, 47, 77, 110, 150, 160			210, 240			320			350, 420		
	Fixed 15, 21, 35, 50, 75, 85			90, 150			230			-		
Accessories												
Undervoltage release **	<input type="checkbox"/>			<input type="checkbox"/>			<input type="checkbox"/>			<input type="checkbox"/>		
Undervoltage release with time delay	<input type="checkbox"/>			<input type="checkbox"/>			<input type="checkbox"/>			<input type="checkbox"/>		
Shunt trip	<input type="checkbox"/>			<input type="checkbox"/>			<input type="checkbox"/>			<input type="checkbox"/>		
Closing coil	<input type="checkbox"/>			<input type="checkbox"/>			<input type="checkbox"/>			<input type="checkbox"/>		
Auxiliary contact block	<input type="checkbox"/>			<input type="checkbox"/>			<input type="checkbox"/>			<input type="checkbox"/>		
Motor control mechanism	<input type="checkbox"/>			<input type="checkbox"/>			<input type="checkbox"/>			<input type="checkbox"/>		
Inverser lock	<input type="checkbox"/>			<input type="checkbox"/>			<input type="checkbox"/>			<input type="checkbox"/>		

* 4 pole 4000A switch is produced with drawer.

■ standards, □ optional

** Opening time can be set as 1s, 3s, 5s, 7s, 9s, 10s.

Generator			Breaker
kVA	kW	A	A
375	300	546	630
438	350	637	800
500	400	730	800
625	500	910	1000
750	600	1090	1250
875	700	1274	1600
1000	800	1460	1600
1125	900	1640	2000
1250	1000	1820	2000
1563	1250	2280	2500
1875	1500	2730	3200
2188	1750	3180	3200
2500	2000	3640	4000

Motor		Breaker
kW	A	A
220	368	630
250	415	630
315	521	800
355	588	800
400	665	800
450	743	1000
500	819	1000
560	916	1250
630	1022	1250

Capacitor Power	Capacitor Current	Breaker Current
kVAr	A	A
578	834	1250
739	1067	1600
924	1334	2000
1155	1667	2500
1478	2134	3200

AIR TYPE CIRCUIT BREAKERS

Order Codes:

Type	Rated Current (A)	Icu 415V	Fixed Type	Drawer Type
F121E	630A ... 2000A	70	9AL-ESS4□-△△△△	9AL-ESC4□-△△△△
F122E	630A ... 2000A	80	9AL-EMS4□-△△△△	9AL-EMC4□-△△△△
F123E	630A ... 2000A	100	9AL-EHS4□-△△△△	9AL-EHC4□-△△△△
F131E	2500A - 3200A	70	9AM-ESS4□-△△△△	9AM-ESC4□-△△△△
F132E	2500A - 3200A	80	9AM-EMS4□-△△△△	9AM-EMC4□-△△△△
F133E	2500A - 3200A	100	9AM-EHS4□-△△△△	9AM-EHC4□-△△△△
F141E	4000	70	9AN-ESS4□-△△△△	9AN-ESC4□-△△△△
F142E	4000	80	9AN-EMS4□-△△△△	9AN-EMC4□-△△△△
F143E	4000	100	9AN-EHS4□-△△△△	9AN-EHC4□-△△△△
F151E	5000A - 6300A	70	-	9AS-ESC4□-△△△△
F152E	5000A - 6300A	80	-	9AS-EMC4□-△△△△
F153E	5000A - 6300A	120	-	9AS-EHC4□-△△△△

□ : Number of poles (3,4)

△△△△: Enter ampere value.

Selection of Air Type Circuit Breaker for Transformer

Transformer power and parallel connected number (kVA)	Transformer rated current In(A)	Short circuit current (kA)	Circuit breaker minimum breaking capacity (kA)	Circuit breaker type	Circuit breaker minimum breaking capacity (Branch Circuit)(kA)
1x800	1156	19,2	20	F121E - 1250	20
2x800	1156	19,2	20	F121E - 1250	40
3x800	1156	19,2	40	F121E - 1250	60
1x1000	1445	24	25	F121E - 1600	25
2x1000	1445	24	25	F121E - 1600	50
3x1000	1445	24	50	F121E - 1600	75
1x1250	1805	30	30	F121E - 2000	30
2x1250	1805	30	30	F121E - 2000	60
3x1250	1805	30	60	F121E - 2000	90
1x1600	2312	38,5	40	F131E - 2500	40
2x1600	2312	38,5	40	F131E - 2500	75
3x1600	2312	38,5	80	F132E - 2500	110
1x2000	2900	48,2	50	F131E - 3200	50
2x2000	2900	48,2	50	F131E - 3200	100
1x2500	3600	60	60	F141E - 4000	60
2x2500	3600	60	60	F141E - 4000	120
1x3150	4450	75,8	80	F152E - 5000	80

Ambient Temperature Impact on Rated Operating Current of Circuit Breaker

Temperature (°C)	F121E (A)						F131E (A)		F141E (A)	F151E (A)	
40	630	800	1000	1250	1600	2000	2500	3200	4000	5000	6300
45	630	800	1000	1250	1600	1900	2400	3000	3800	5000	6300
50	630	800	1000	1250	1500	1900	2300	3000	3600	5000	6300
55	630	800	1000	1200	1500	1800	2200	2800	3400	4800	6100
60	610	800	1000	1150	1300	1700	2200	2800	3200	4800	6100
65	610	800	1000	1150	1300	1650	2200	2600	3200	4800	6100

AIR TYPE CIRCUIT BREAKERS

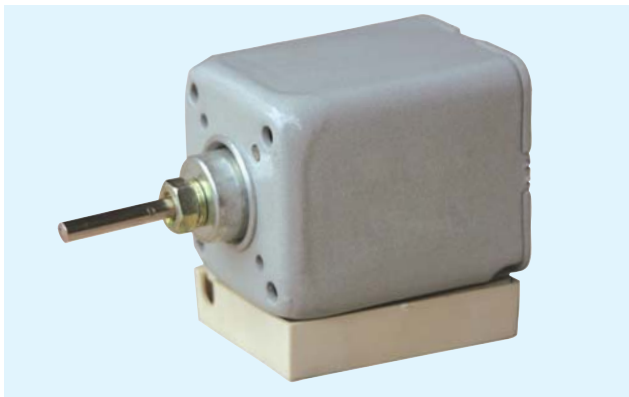

Undervoltage Release : Undervoltage release is used in opening air type circuit breaker due to low voltage or phase disconnection. There are two types of low voltage releasers as instant opening and delayed opening types. Delayed type undervoltage release has 1 sec., 2 sec. and 5 sec. delayed models and accuracy class is 15%.

Characteristic

Rated control power voltage U_s (V)	AC 230, 400
Actuation voltage (V)	(0.85-1.1) U_e
Release voltage	(0.35-0.7) U_e
Power consumption	48 W

Order Code	Delayed	8AM-CA000-0220
	Non-delayed	8AM-CA001-0220



Closing Release: After the motor mechanism completes energy storage, the closing coil promptly closes the breaker by releasing the spring in the mechanism.

Characteristic

Rated control power voltage U_s (V)	AC 230, 400
Operating voltage	(0.85-1.1) U_s
Power consumption	40 W
Closing time	< 70 ms

Order Code	8AM-BD000-0222
------------	----------------

Shunt Trip Release: Air type circuit breakers, other than manual type, may be remote controlled with shunt trip coil.

Characteristic

Rated control power voltage U_s (V)	AC 230, 400
Operating voltage	(0.7-1.1) U_s
Power consumption	40 W
Closing time	< 30 ms

Order Code	8AM-BD000-0221
------------	----------------



Motor Mechanism: Motor mechanism sets the mechanism springs (energy storage) and has the breaker ready for closing.

Characteristic

Rated control power voltage U_s (V)	AC 230, 400
Operating voltage	(0.85-1.1) U_s
Power consumption	190 W
Setup period	4 sec

Order Code	
F121E/F123E	8AM-DA000-0220
F131E/F133E-F141/F143E	8AS-DA000-0220
F151E/F153E	

Mechanical Lock:

One of 2 normal power supplies is active.

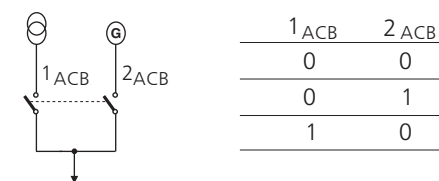

Cable wire type mechanical lock is used in cross locking of 2 circuit breakers in vertical or horizontal positions. The purpose of this application is to prevent accidental ON-1 position of one circuit breaker, while the other is in ON-1 position.

Order Code: 8AM-V0000-0000

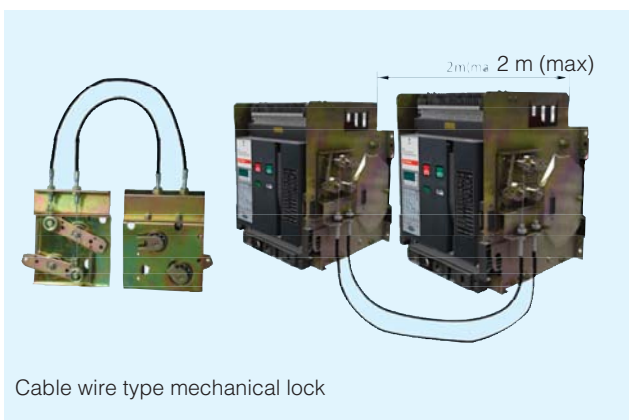

Cable wire type mechanical lock

AIR TYPE CIRCUIT BREAKERS

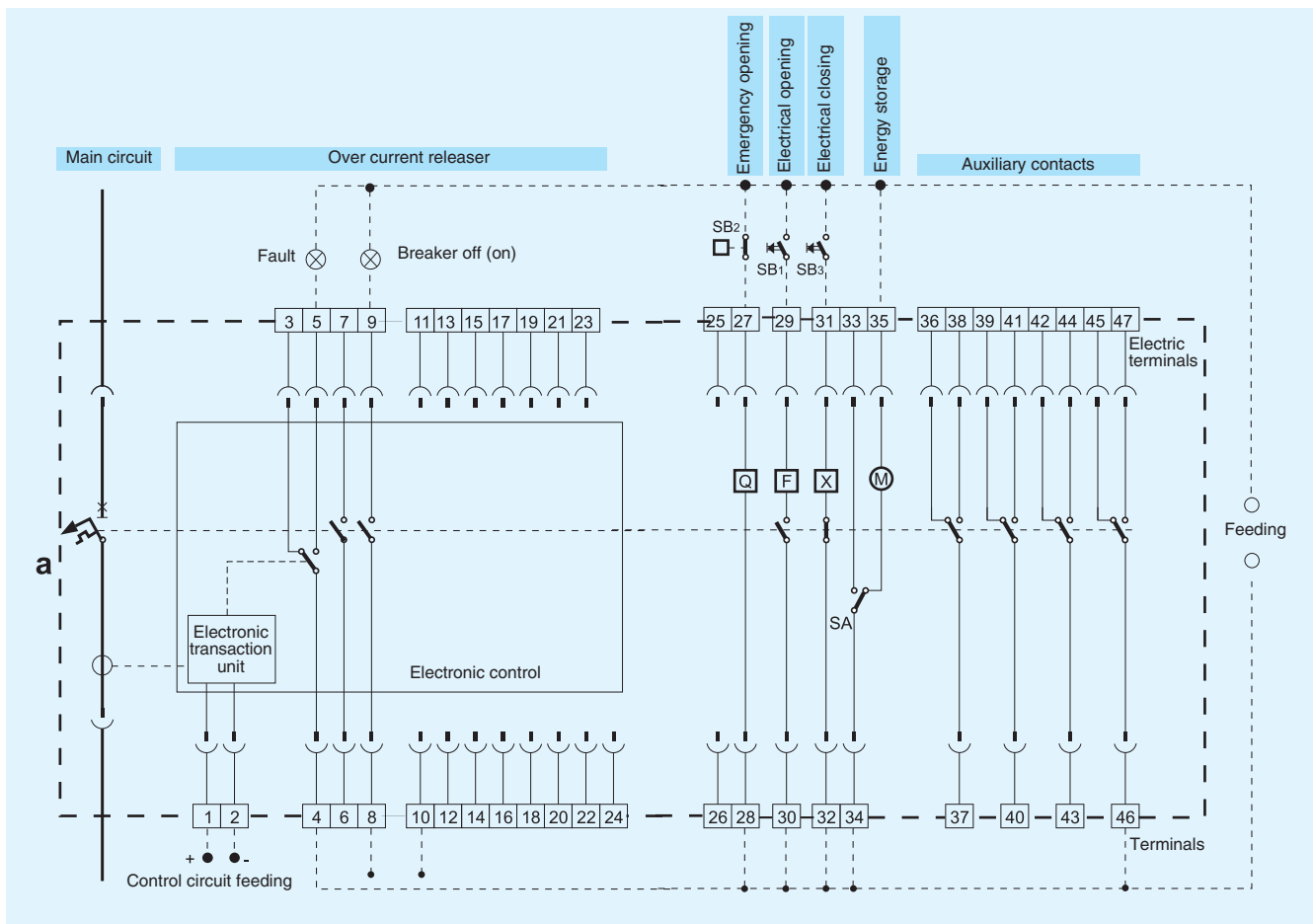

- a : Circuit breaker
- M : Energy storage (setting) motor
- F : Remote shunt trip coil
- X : Remote closing coil
- Q : Undervoltage release (instant or delayed)
- (↔) : Connection sockets
- SB1 : Remote shunt trip button
- SB2 : Emergency opening button
- SB3 : Remote closing button
- ⊗ : Signal lamp
- : Device borders
- - - : Connections to be made by user
- : Terminals

Note-1: If Q, F, X and M control voltages are different from each other, these might be connected to different powers. Energy storage (setting) motor electric terminal (35) may be connected to the feeding directly or via a start button.

Note-2: Closing and opening coils burn if they are subject to energy continuously. Therefore, closing coils should be operated as serially connected to normally closed auxiliary contacts (e.g. 36-37); and opening coils should be operated as serially connected to normally open auxiliary contacts (e.g. 40-41).



Federal air type circuit breaker control circuit electric terminals can be easily accessed without removing the front cover.

AIR TYPE CIRCUIT BREAKERS

Characteristic Curves:

Current-Time Curve:

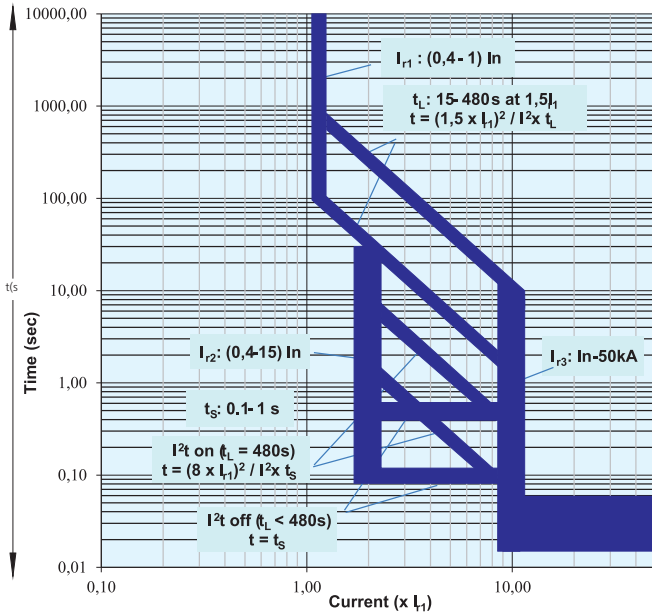

Ground Fault Protection Current-Time Curve:

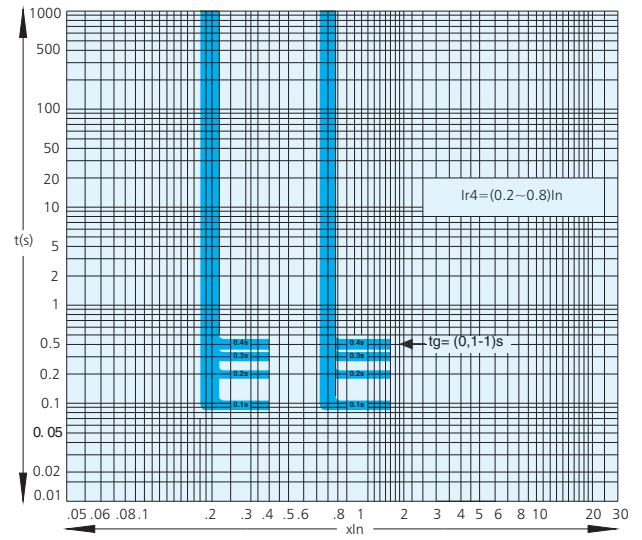

I² T Curve:

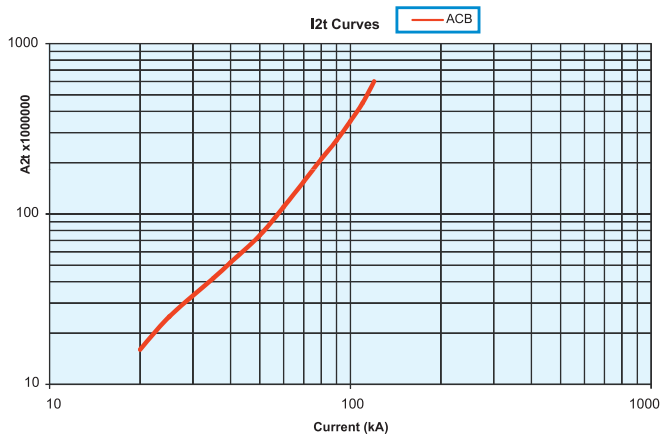

Load-Dependent Values (1):

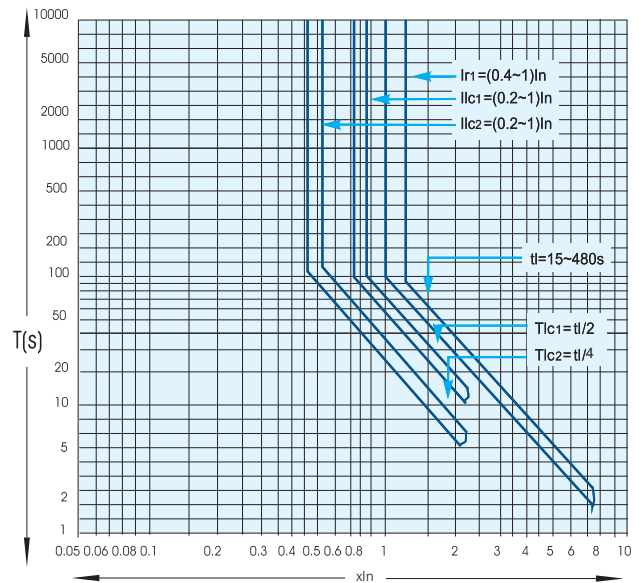

Load-Dependent Values (2):

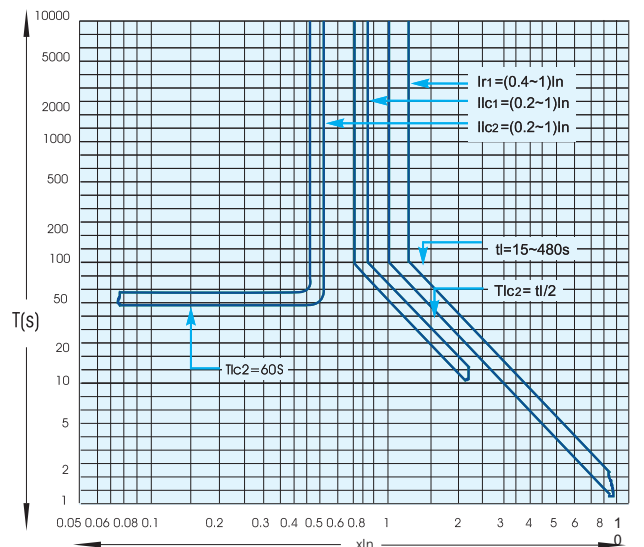

AIR TYPE CIRCUIT BREAKERS

F121E-F122E-F123E (Fixed Type)

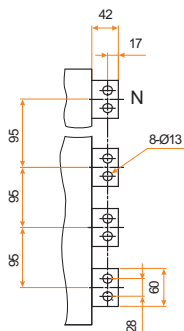
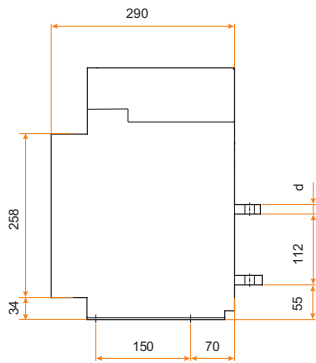

Busbar Connections

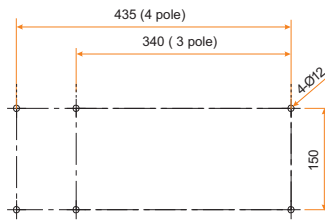
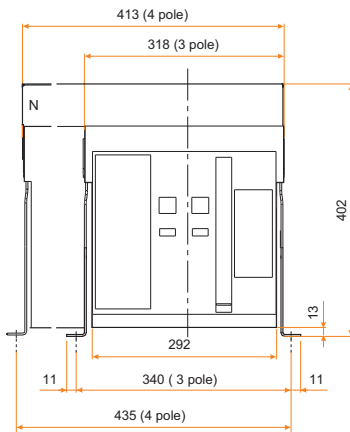

Assembling Gauge

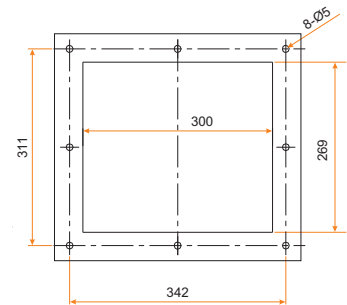

Panel Frame

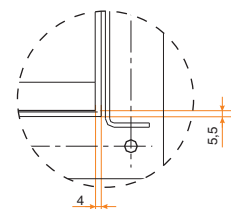

In A	busbar thickness d (mm)
630-800	10
1000-1600	15
2000	20

F121E-F122E-F123E (Drawout Type)

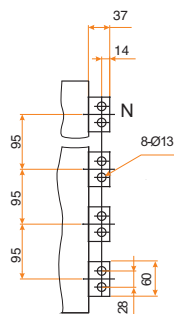
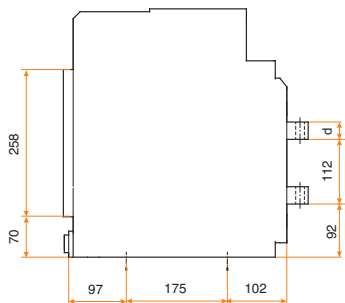

Busbar Connections

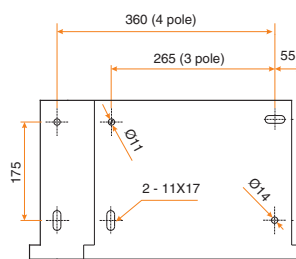
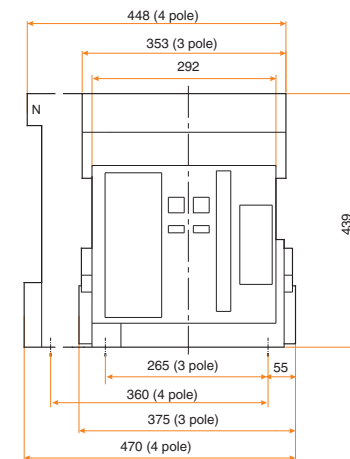

Assembling Gauge

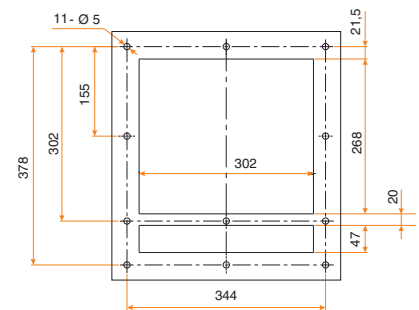

Panel Frame

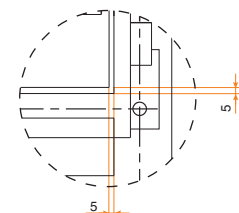

In A	busbar thickness d (mm)
630-800	10
1000-1600	15
2000	20

AIR TYPE CIRCUIT BREAKERS

F131E-F132E-F133E (Fixed Type)

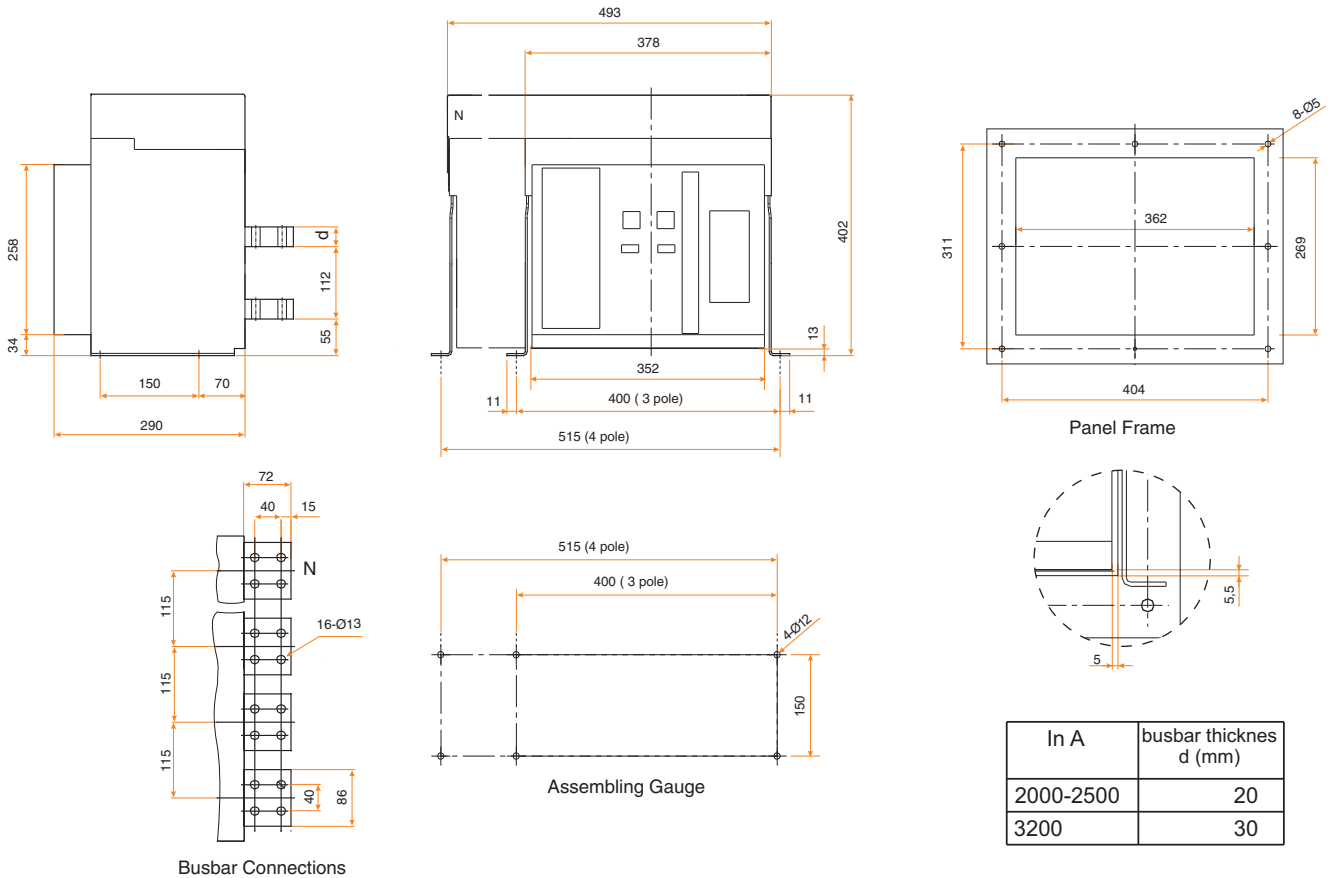

F131E-F132E-F133E (Drawout Type)

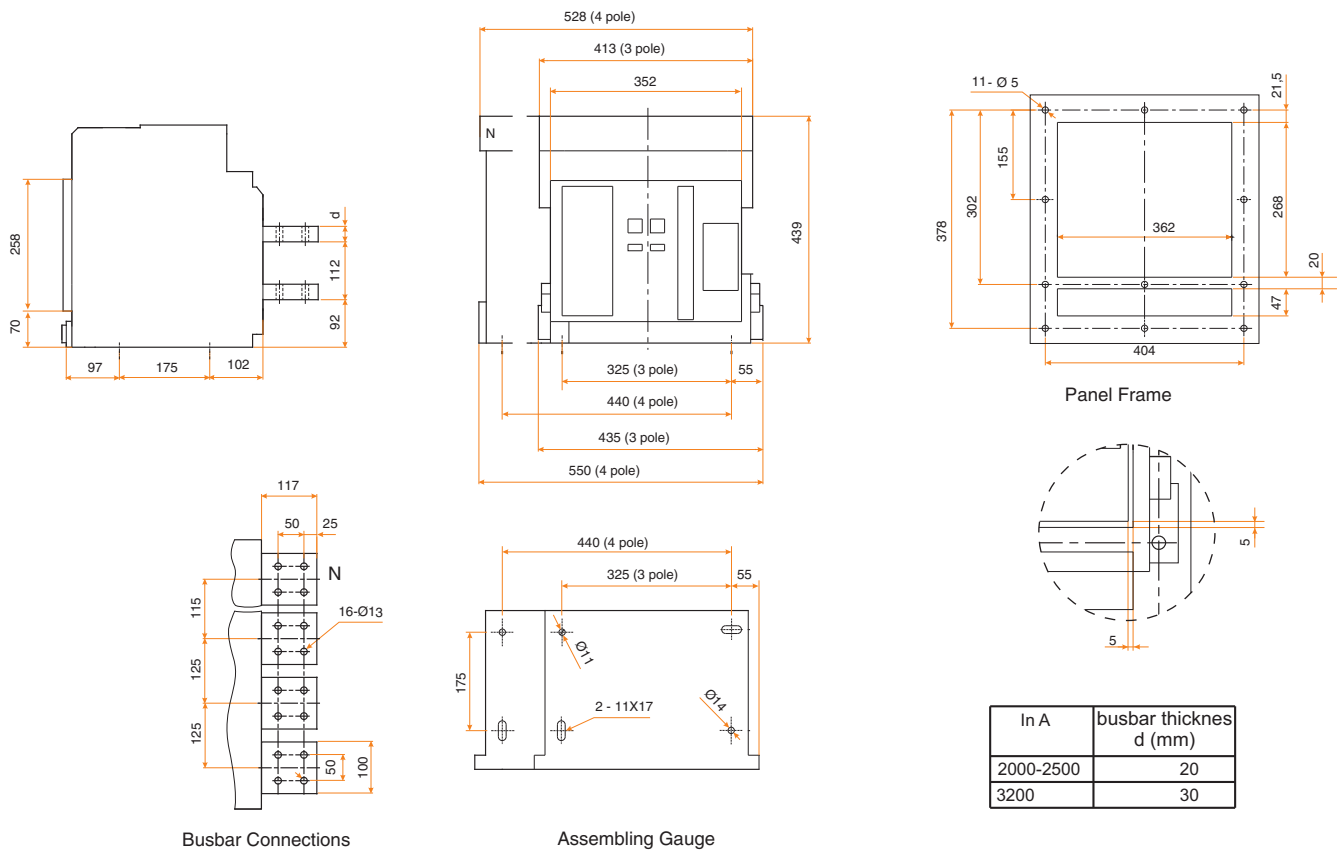

AIR TYPE CIRCUIT BREAKERS

F141E-F142E-F143E (Fixed Type)

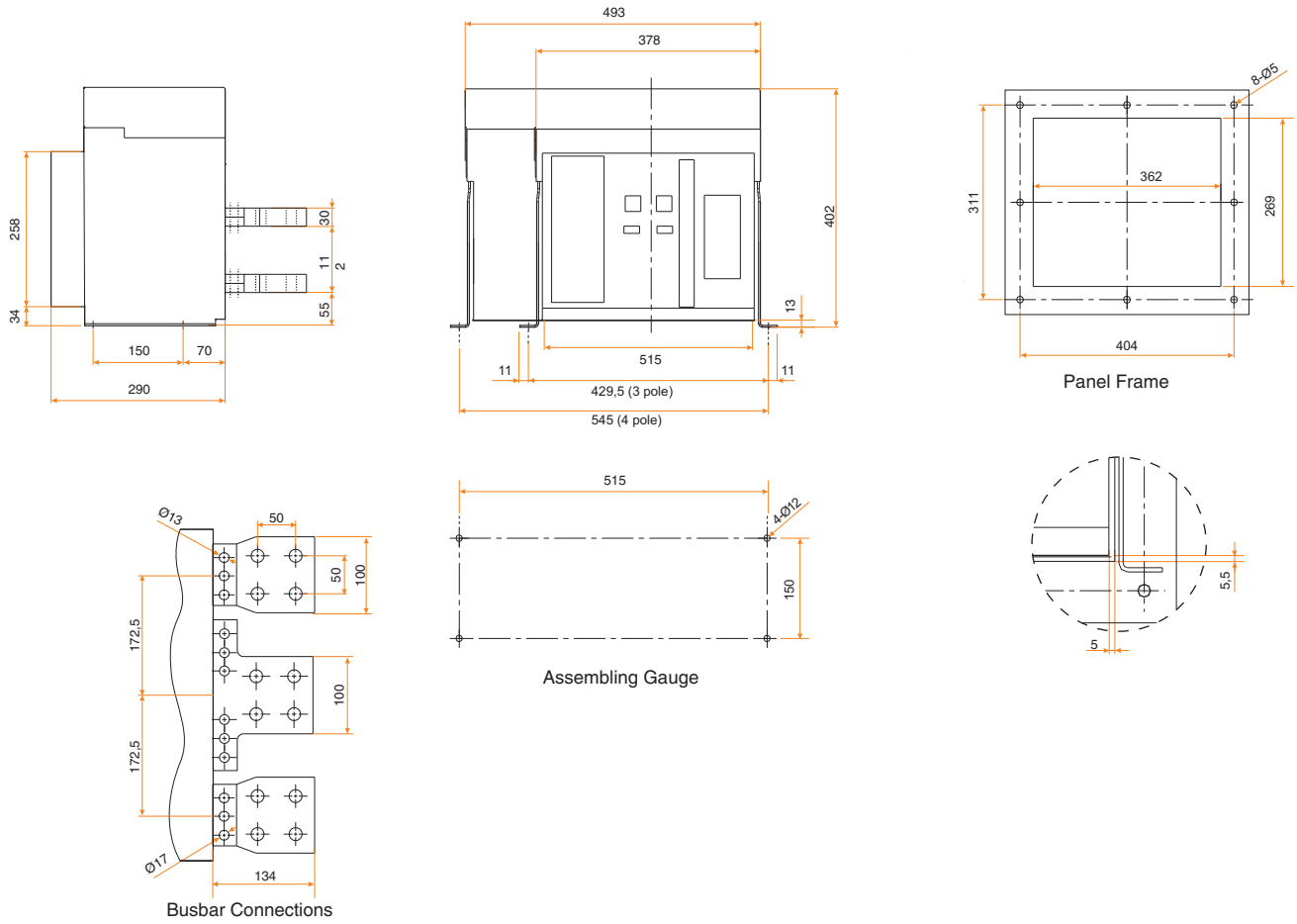

F141E-F142E-F143E (Drawout Type)

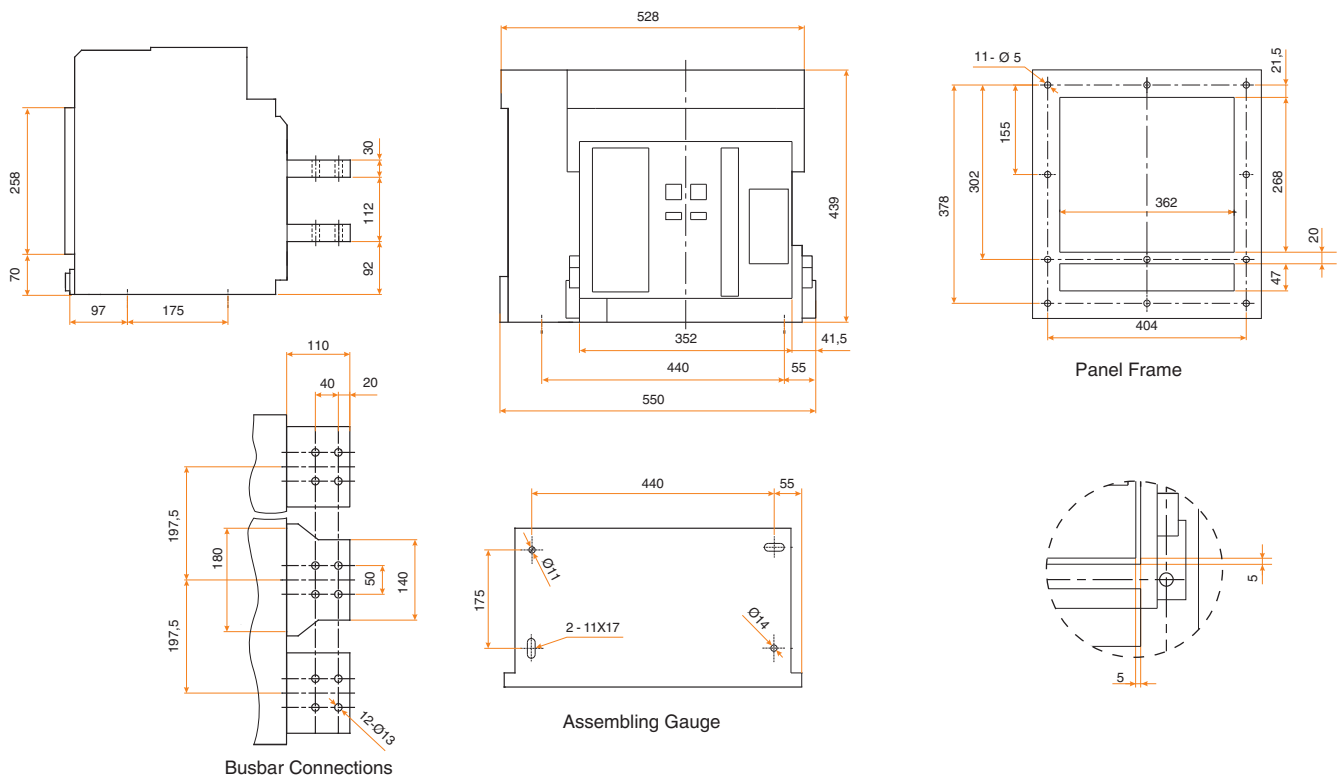

AIR TYPE CIRCUIT BREAKERS

F151E-F152E-F153E (Drawout Type)

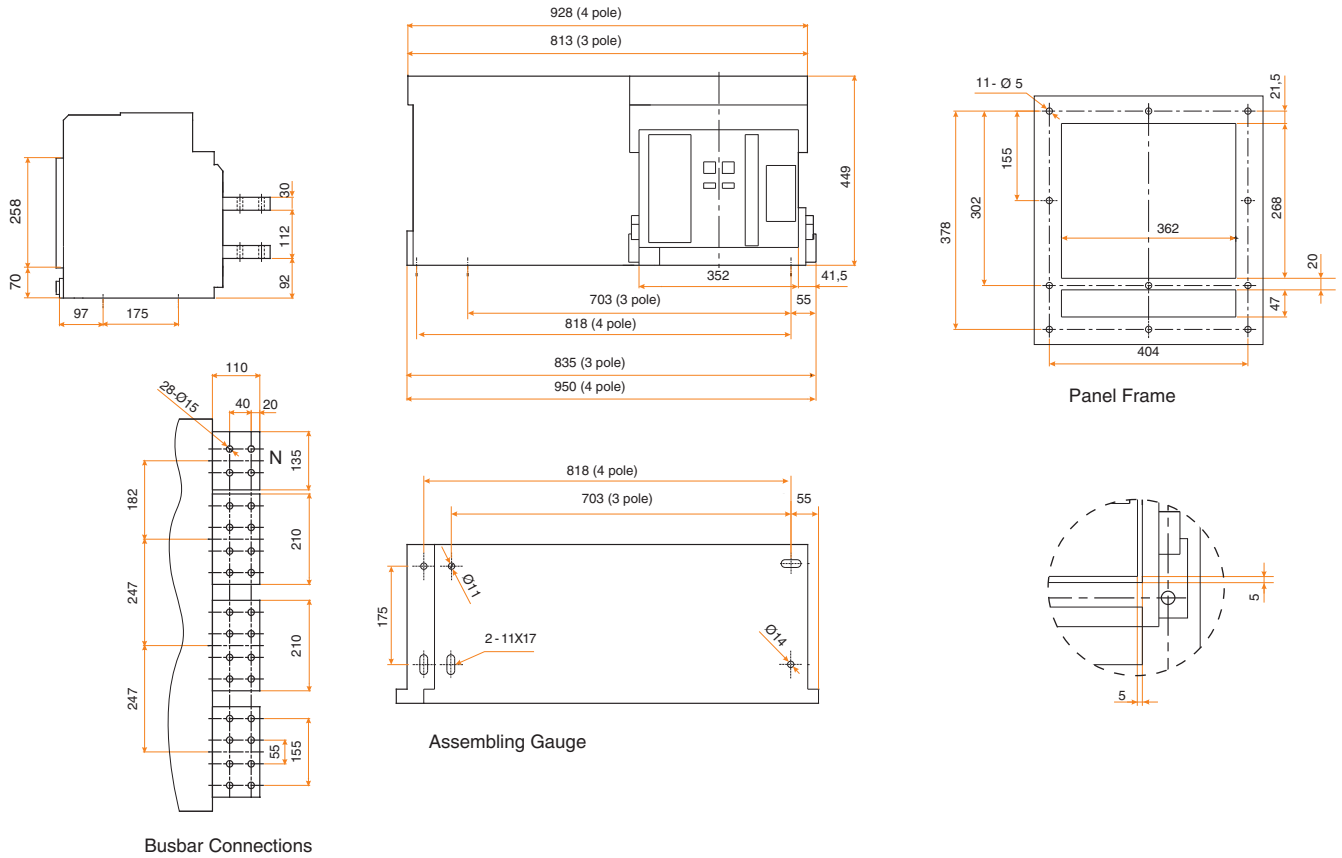

Wiring Diagram Of Change Over Systems For Air Circuit Breakers

