



# Kraus & Naimer

BLUE LINE switchgear

since 1907

## Catalog 110 Control Switches for Special Applications

09/2009

A type up to 25 A  
AD type up to 6 A

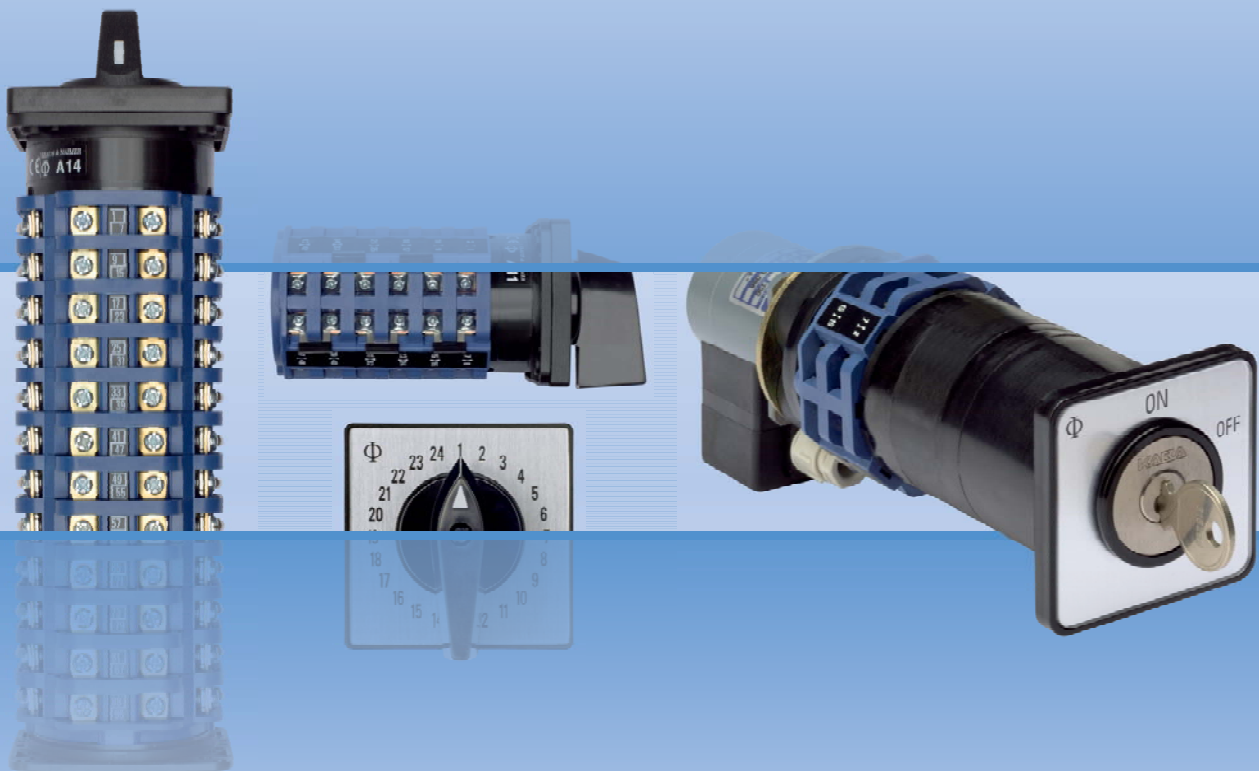

---

# Kraus & Naimer

The development of the Blue Line rotary switch, contactor and motor starter product ranges is based on more than hundred years experience by Kraus & Naimer in the design and manufacture of electrical switchgear. Kraus & Naimer pioneered the introduction of the cam operated rotary switch and continues to be recognized as the world leader in that product field.

## BLUE LINE

Blue Line products are protected by numerous patents throughout the industrial world. They are built to national and international standards and designed to withstand adverse temperatures and climates.

Blue Line products are accepted and universally recognized for their quality and workmanship. They are supported by a worldwide sales and service organization.

The Kraus & Naimer Registered Trademark



WORLDWIDE SYMBOL  
FOR QUALITY SWITCHGEAR

---

---

Disconnectors and Main Switches acc. to IEC 60947-3 see Catalog 500

<b>Contents</b>	<b>Page</b>
Construction Data	2
Dimensions and Nominal Ratings	2
How to order	3, 4
Switch Function and Configuration	
ON/OFF Switches	5, 6
Double-throw Switches	7, 8
Multi-step Switches	9-11
General Application Switches	12
Voltmeter Switches	13
Ammeter Switches	14
Control Switches	15
Motor Switches	16
Types of Mounting	
Panel Mounting	17, 18
Base Mounting	18
Handles	19
Escutcheon Plates	20, 21
Technical Data	22, 23
International Standards and Approvals	24
Dimensions	
Handles and Escutcheon Plates	25
Panel Mounting	26, 27
Base Mounting	27
Overall Switch Lengths	27
Blue Line Switchgear: Summary	28

---

## Construction Data

### A Switches

A switches are used in applications where available depths behind the mounting plates are limited and the switching programs require a large number of contacts. They are used when more than 12 switching positions are required. Typical applications for A switches are multi-step switches, multi-pole step switches, instrumentation switches and control switches where depth problems exist. The A switch has 4 double-break contacts which are controlled by two independent cams.

The switch column can contain up to 12 stages representing a total of 48 contacts. Additional contacts can be added by using a tandem drive to operate more than one switch column with a single handle.



Switch type	Switching angle	Max. number of switch positions
A11, AD11, AD12	15°, 20°, 30°, 45°, 60°, 90°	24
A14	20°, 30°, 45°, 60°, 90°	18

A wide range of optional extras, escutcheon plates, handles, mountings and enclosures is available.

### 2 different Contact Systems are available

A11 and A14

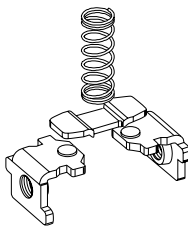

A rigid, double-break bridge with silver alloy contacts provides high making and breaking capabilities for regular control applications.

AD11 and AD12

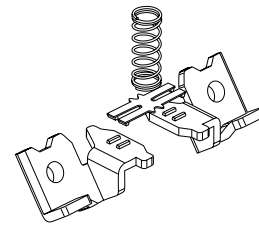

High contact reliability by H-bridge design with self-cleaning "cross-wire" contacts. The contact system with gold-plated contacts (AD12 with silver contact) allows for low voltages, electronic compatible.

### Switch Size

### Type

### Rated Values

Switch Size	Type	According to IEC 60947-3/VDE 0660 part 107		
		Thermal Current $I_u/I_{th}$ <b>A</b>	Motor Rating 3 x 380 V/440 V AC-23A <b>kW</b>	Operational Current $I_e$ AC-21A AC-15/220 V <b>A</b>
<b>S1</b>	<b>AD11</b>	6	-	1 V/ 6 A 24 V/ 1 A 110 V/ 0,4 A 220 V/ 0,2 A 380 V/ 0,13 A
	<b>AD12</b>	6	-	6 V/ 6 A 24 V/ 5 A 110 V/ 3 A 220 V/ 2 A 380 V/ 1,3 A
	<b>A11</b>	20	7,5	20 A
	<b>A14</b>	25	11	25 A
<b>S2</b>	<b>A11C</b>	20	7,5	20 A
	<b>A14C</b>	25	11	25 A

## How to order

Disconnectors and Main Switches according to IEC 60947-3 see Catalog 500

Three types of data (shown below) are required for ordering Blue Line cam-operated switches. Code numbers for ordering are shown in this catalog.

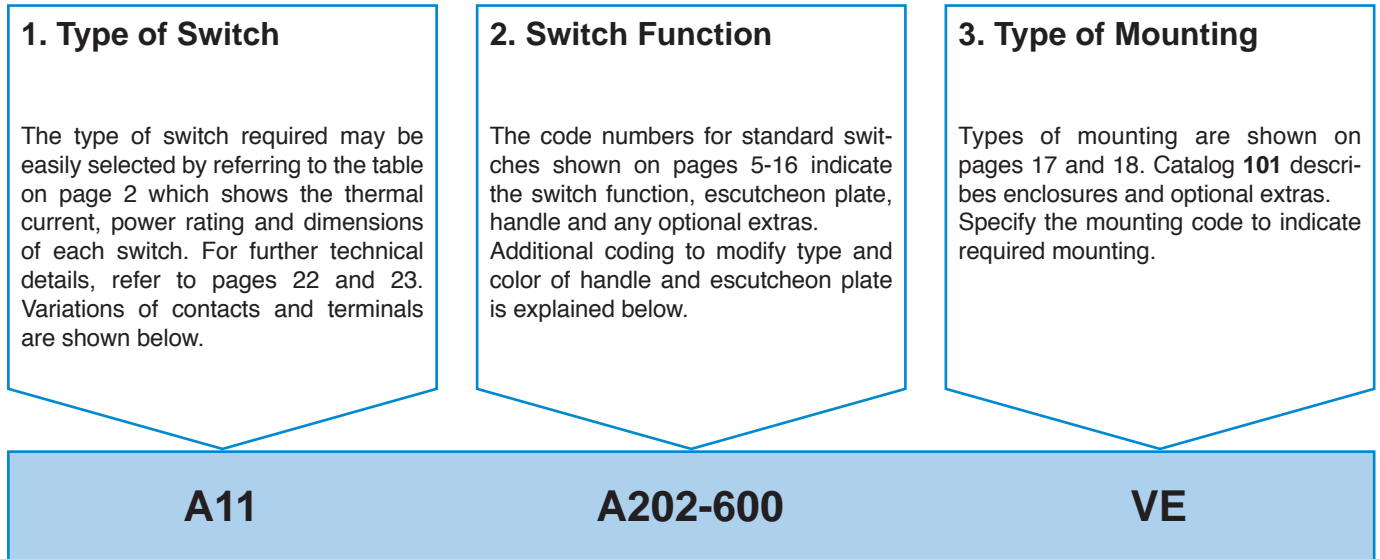

### Type of Switch

Extending the switch type coding the following combinations will define:

Amendment	Definition	For switch types
-1	with gold contacts <sup>1</sup>	A11, A11C, A14, A14C
-4	with quick connects	A11, A11C
-5	with quick connects and gold contacts	A11, A11C
C	S1 switches with latching mechanism size S2	A11, A14
L	with lockout-relay w/o manual release for std. switches	A11, AD11, AD12, A14
M	with lockout-relay with manual release for std. switches	A11, AD11, AD12, A14
X	with power failure release	A11, AD11, AD12, A14

**Example:** Coding for switch type **A11** with gold contacts is **A11-1**.

### Modification of Switches

The part number for switch function and options may be modified in cases where items are required other than standard. The modification may involve the escutcheon plate inscription, color combination of escutcheon plate and handle, type of escutcheon plate and handle, or the optional extra.

Size	Escutcheon Plate Frame	Handle	Escutcheon Plate Backing	Escutcheon Plate Lettering	Dash-Number
S1, S2	electro-gray	electro-gray	brushed alu	black	-100
S1, S2	electro-gray	electro-gray	black	mat silver	-500
S1, S2	black	black	brushed alu	black	-600
S1, S2	black	black	black	mat silver	-700

The standard switch consists of a transparent escutcheon plate with brushed aluminum backing and black inscription. The escutcheon plate frame is black as well as the handle. Above there are further color combinations of escutcheon plate and handle which are available. The appropriate dash-number must be substituted in the switch function coding to specify other color combinations as required.









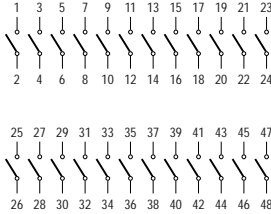

**Example:** The complete coding for switch type **A11** with a 3 pole ON/OFF switch function, electro-gray handle and electro-gray escutcheon plate frame with brushed aluminum backing and black inscription which reads 0-1 is as follows: **A11 A202-100 E**.

<sup>1</sup>Technical data on request.

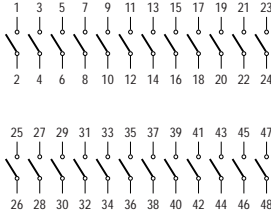



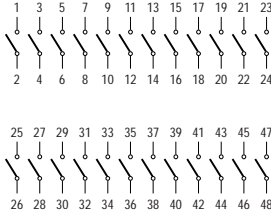

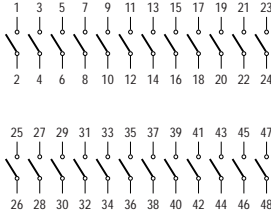
Function	Escutch. Plate	Handle	Code	Stages	Connection Diagram
----------	----------------	--------	------	--------	--------------------

**ON/OFF Switches with 60° Switching**





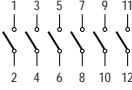

1 pole			A200-600	1	
2 pole			A201-600	1	
3 pole			A202-600	1	
3 pole with red handle			A202-626	1	
3 pole with V850 padlock attachment			A202-627	1	
4 pole			A203-600	1	
5 pole			A341-600	2	
6 pole			A342-600	2	
8 pole			A344-600	2	
10 pole			A346-600	3	
12 pole			A348-600	3	
14 pole			A350-600	4	
16 pole			A352-600	4	
18 pole			A354-600	5	
20 pole			A356-600	5	
22 pole			A358-600	6	
24 pole	A360-600	6			
1 pole			A200-620	1	
2 pole			A201-620	1	
3 pole			A202-620	1	
4 pole			A203-620	1	
5 pole			A341-620	2	
6 pole			A342-620	2	
8 pole			A344-620	2	
10 pole			A346-620	3	
12 pole			A348-620	3	
14 pole			A350-620	4	
16 pole			A352-620	4	
18 pole			A354-620	5	
20 pole			A356-620	5	
22 pole			A358-620	6	
24 pole			A360-620	6	
1 pole					
2 pole	A201-621	1			
3 pole	A202-621	1			
4 pole	A203-621	1			
5 pole	A341-621	2			
6 pole	A342-621	2			
1 pole			A200-622	1	
2 pole			A201-622	1	
3 pole			A202-622	1	
4 pole			A203-622	1	
5 pole			A341-622	2	
6 pole			A342-622	2	
1 pole			A200-623	1	
2 pole			A201-623	1	
3 pole			A202-623	1	
4 pole			A203-623	1	
5 pole			A341-623	2	
6 pole			A342-623	2	

Function	Escutch. Plate	Handle	Code	Stages	Connection Diagram
----------	----------------	--------	------	--------	--------------------

**ON/OFF Switches with 60° Switching**

1 pole			A200-624	1	
2 pole			A201-624	1	
3 pole			A202-624	1	
4 pole			A203-624	1	
5 pole			A341-624	2	
6 pole			A342-624	2	
1 pole			A200-625	1	<p>1-6 pole</p>
2 pole			A201-625	1	
3 pole			A202-625	1	
4 pole			A203-625	1	
5 pole			A341-625	2	
6 pole			A342-625	2	

**ON/OFF Switches with 90° Switching**

1 pole contacts preclose 30°			A290-600	1	 <p>contacts preclose 30°</p>
2 pole contacts preclose 30°			A291-600	1	
3 pole contacts preclose 30°			A292-600	1	
4 pole 1 contact precloses 60° 3 contacts preclose 30°			A293-600	1	<p>1-3 pole</p>
1 pole contacts preclose 30°			A290-620	1	 <p>3 contacts preclose 30° 1 contact precloses 60°</p>
2 pole contacts preclose 30°			A291-620	1	
3 pole contacts preclose 30°			A292-620	1	
4 pole 1 contact precloses 60° 3 contacts preclose 30°			A293-620	1	



Function	Escutch. Plate	Handle	Code	Stages	Connection Diagram
----------	----------------	--------	------	--------	--------------------

**Double-throw Switches without „OFF“ 60° Switching**

1 pole			A220-600	1	
2 pole			A221-600	1	
3 pole			A222-600	2	
4 pole			A223-600	2	
6 pole			A370-600	3	
8 pole			A372-600	4	
10 pole			A374-600	5	
12 pole			A376-600	6	
14 pole			A660-600	7	
16 pole			A661-600	8	
18 pole	A662-600	9			
20 pole	A663-600	10			

**Double-throw Switches without „OFF“ with electrically isolated contacts**

1 pole			A720-600	1	
2 pole			A721-600	1	
3 pole			A722-600	2	
4 pole			A723-600	2	

**Double-throw Switches with Center „OFF“ 60° Switching**

1 pole			A210-600	1	
2 pole			A211-600	1	
3 pole			A212-600	2	
4 pole			A213-600	2	
5 pole			A361-600	3	
6 pole			A362-600	3	
8 pole			A364-600	4	
10 pole			A366-600	5	
12 pole			A368-600	6	
14 pole			A655-600	7	
16 pole	A656-600	8			
18 pole	A657-600	9			
20 pole	A658-600	10			

Function	Escutch. Plate	Handle	Code	Stages	Connection Diagram
----------	----------------	--------	------	--------	--------------------

**Double-throw Switches with Center „OFF“ 60° Switching**

1 pole 2 pole 3 pole			A210-620 A211-620 A212-620	1 1 2	 1-4 and 6-8 pole	
4 pole 5 pole 6 pole 8 pole			A213-620 A361-620 A362-620 A364-620	2 3 3 4		
1 pole 2 pole 3 pole			A210-621 A211-621 A212-621	1 1 2		
1 pole 2 pole 3 pole			A210-622 A211-622 A212-622	1 1 2		
1 pole 2 pole 3 pole			A210-623 A211-623 A212-623	1 1 2		 5 pole
1 pole 2 pole 3 pole 4 pole			A210-624 A211-624 A212-624 A213-624	1 1 2 2		

**Double-throw Switches with Center „OFF“ and electrically isolated contacts**















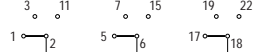



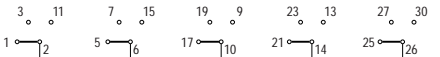

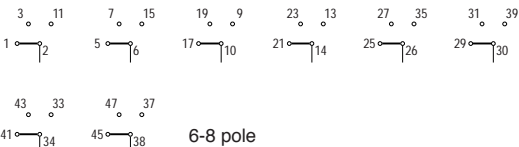



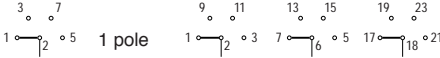



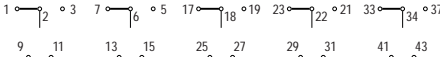
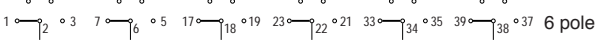







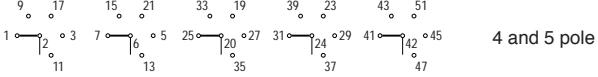





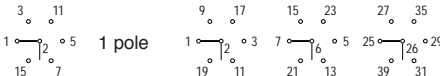
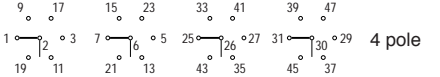





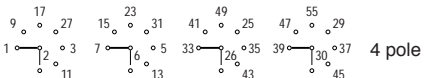

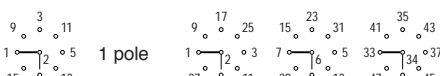

1 pole 2 pole 3 pole			A710-600 A711-600 A712-600	1 1 2	 1-3 pole
1 pole with spring return to center 2 pole with spring return to center 3 pole with spring return to center			A714-600 A715-600 A716-600	1 1 2	 1-3 pole

**Double-throw Switches with Spring Return to Center**

1 pole with spring return to center 2 pole with spring return to center 3 pole with spring return to center			A214-600 A215-600 A216-600	1 1 2	 1-3 pole
1 pole with spring return to center 2 pole with spring return to center 3 pole with spring return to center			A214-620 A215-620 A216-620	1 1 2	

Function	Escutch. Plate	Handle	Code	Stages	Connection Diagram
----------	----------------	--------	------	--------	--------------------

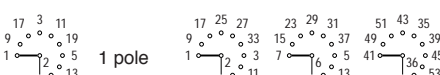
Multi-step Switches without „OFF“

1 pole 2 pole 3 pole		  	A230-600 A250-600 A270-600	1 2 3	 1 pole  2 and 3 pole
4 pole 5 pole 6 pole		  	A476-600 A484-600 A489-600	3 4 5	 4 and 5 pole
7 pole 8 pole		 	A494-600 A497-600	6 6	 6-8 pole
1 pole 2 pole 3 pole		  	A231-600 A251-600 A271-600	1 2 3	 2 and 3 pole
4 pole 5 pole 6 pole		  	A477-600 A485-600 A490-600	4 5 6	 4 and 5 pole  6 pole
1 pole 2 pole 3 pole 4 pole 5 pole		    	A232-600 A252-600 A272-600 A478-600 A676-600	2 3 4 5 7	 2 and 3 pole  4 and 5 pole
1 pole 2 pole 3 pole 4 pole		   	A233-600 A253-600 A273-600 A479-600	2 3 5 6	 2 and 3 pole  4 pole
1 pole 2 pole 3 pole 4 pole		   	A234-600 A254-600 A274-600 A670-600	2 4 6 7	 2 and 3 pole  4 pole
1 pole 2 pole 3 pole 4 pole		   	A235-600 A255-600 A275-600 A671-600	2 4 6 8	 2 and 3 pole  4 pole
1 pole 2 pole 3 pole 4 pole		   	A236-600 A256-600 A276-600 A672-600	3 5 7 9	 2 and 3 pole  4 pole

# Switch Function and Configuration

# A Switches

Function	Escutch. Plate	Handle	Code	Stages	Connection Diagram
----------	----------------	--------	------	--------	--------------------

## Multi-step Switches without „OFF“

1 pole 2 pole 3 pole			A237-600 A257-600 A277-600	3 5 8	1 pole            2 and 3 pole
1 pole 2 pole 3 pole			A238-600 A258-600 A278-600	3 6 9	1 pole            2 and 3 pole
1 pole 2 pole 3 pole			A239-600 A259-600 A279-600	3 6 9	1 pole            2 and 3 pole

## Multi-step Switches with „OFF“

1 pole 2 pole 3 pole 5 pole			A240-600 A260-600 A280-600 A486-600	1 1 2 3	1- and 2 pole
1 pole 2 pole 3 pole 5 pole			A240-620 A260-620 A280-620 A486-620	1 1 2 3	3 and 5 pole
1 pole 2 pole 3 pole 5 pole			A241-600 A261-600 A281-600 A487-600	1 2 3 4	2 and 3 pole
1 pole 2 pole 3 pole 5 pole			A241-620 A261-620 A281-620 A487-620	1 2 3 4	5 pole
1 pole 2 pole			A241-621 A261-621	1 2	
1 pole 2 pole 3 pole			A242-600 A262-600 A282-600	1 2 3	2 and 3 pole
1 pole 2 pole 3 pole			A242-620 A262-620 A282-620	1 2 3	
1 pole 2 pole 3 pole			A243-600 A263-600 A283-600	2 3 5	2 and 3 pole
1 pole 2 pole 3 pole			A243-620 A263-620 A283-620	2 3 5	
1 pole 2 pole 3 pole			A244-600 A264-600 A284-600	2 3 5	2 and 3 pole
1 pole 2 pole 3 pole			A244-620 A264-620 A284-620	2 3 5	





Function	Escutch. Plate	Handle	Code	Stages	Connection Diagram
----------	----------------	--------	------	--------	--------------------

Multi-step Switches with „OFF“

1 pole 2 pole 3 pole			A245-600	2	1 pole                      2 pole
			A265-600	4	
			A285-600	6	
1 pole 2 pole 3 pole			A245-620	2	1 pole                      2 pole                      3 pole
			A265-620	4	
			A285-620	6	
1 pole 2 pole 3 pole			A246-600	2	1 pole                      2 pole
			A266-600	4	
			A286-600	6	
1 pole 3 pole			A246-620	2	1 pole                      3 pole
			A286-620	6	
				6	
1 pole 2 pole 3 pole			A247-600	3	1 pole                      2 pole
			A267-600	5	
			A287-600	8	
1 pole 3 pole			A247-620	3	1 pole                      3 pole
			A287-620	8	
				8	
1 pole 2 pole 3 pole			A248-600	3	1 pole                      2 pole
			A268-600	5	
			A288-600	9	
1 pole 3 pole			A248-620	3	1 pole                      3 pole
			A288-620	9	
				9	
1 pole 2 pole 3 pole			A249-600	3	1 pole                      2 pole
			A269-600	6	
			A289-600	9	
1 pole 3 pole			A249-620	3	1 pole                      3 pole
			A289-620	9	
				9	
1 pole 2 pole 3 pole			A630-600	3	1 pole                      2 and 3 pole
			A635-600	7	
2 pole 3 pole			A644-600	11	2 and 3 pole
				11	
1 pole			A631-600	4	1 pole
1 pole			A632-600	5	1 pole

Function	Escutch. Plate	Handle	Code	Stages	Connection Diagram
----------	----------------	--------	------	--------	--------------------

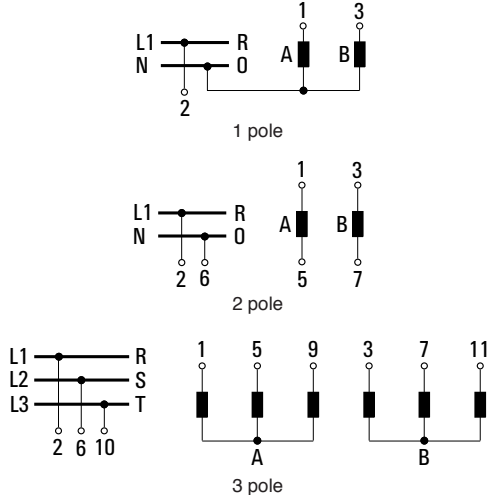
General Application Switches

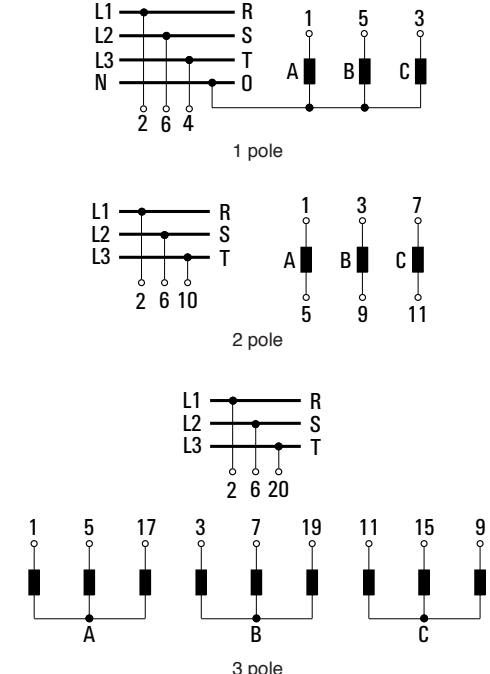
<p>1 pole 2 Gang 2 pole 3 pole</p> <p>Switching sequence: 0, A, A+B</p> <p>1 pole 2 pole 3 pole</p>			<p>A310-600 A312-600 A314-600</p> <p>A310-620 A312-620 A314-620</p>	<p>1 1 2</p> <p>1 1 2</p>	
<p>1 pole 3 Gang 2 pole 3 pole</p> <p>Switching sequence: 0, A, A+B, A+B+C</p> <p>1 pole 2 pole 3 pole</p>			<p>A311-600 A313-600 A315-600</p> <p>A311-620 A313-620 A315-620</p>	<p>1 2 3</p> <p>1 2 3</p>	

Function	Escutch. Plate	Handle	Code	Stages	Connection Diagram
----------	----------------	--------	------	--------	--------------------

Voltmeter Switches with „OFF“

3 phase to phase			A004-600	1	
			A004-620	1	
			A004-621	1	
			A004-622	1	
			A004-623	1	
			A004-624	1	
3 phase to phase and 3 phase to neutral			A007-600	2	
			A007-620	2	
			A007-621	2	
			A007-622	2	
			A007-623	2	
			A007-624	2	
2 separate 3 phase with center „OFF“			A008-600	2	
			A008-620	2	
			A008-621	2	
			A008-622	2	

Function	Escutch. Plate	Handle	Code	Stages	Connection Diagram
----------	----------------	--------	------	--------	--------------------

**Ammeter Switches**

Single pole with 3 current transformers with „OFF“ 360° rotation			A048-600	2	
			A048-620	2	
			A048-621	2	
			A048-622	2	
			A048-623	2	
Single pole with 2 current transformers (3 readings)			A021-600	1	
			A021-620	1	
2 pole, 3 current transformers			A019-600	3	
			A019-620	3	
			A038-600	3	
			A038-620	3	
			A038-621	3	



Function	Escutch. Plate	Handle	Code	Stages	Connection Diagram
----------	----------------	--------	------	--------	--------------------

**Control Switches**

Stop switch			A174-600	1	
Start switch			A175-600	1	
Stop start switch single pole			A176-600	1	
Stop start switch with spring return from start to run			A178-600	1	
			A178-620	1	
Stop start switch with spring return to run for 2 units			A177-600	1	
			A177-620	1	

Function	Escutch. Plate	Handle	Code	Stages	Connection Diagram
----------	----------------	--------	------	--------	--------------------

**Motor Reversing Switches**

3 pole			A401-600	2	
			A401-620	2	
			A401-621	2	

**Star-delta Switches**

Off-star-delta			A410-600	2	
			A410-620	2	
With auxiliary contact closed in „OFF“ position			A416-600	3	











**Motor Control Switches**

2 speed single winding			A440-600	2	
			A440-620	2	
2 speed single winding with center „OFF“			A441-600	2	
			A441-620	2	
2 speed single winding reversing			A442-600	4	
			A442-620	4	

**Motor Control Switches**

3 speed 2 winding 0 - AΔ - BY - AY			A457-600	3	
			A457-620	3	



Four Hole Panel Mounting	Code	A11	A14	A11C
		AD11		A14C

	Panel Mounting	E	●	●	●
	Four hole panel mounting				
	Four hole panel mounting, protection IP 66	ER	●	●	●
	Panel and base mounting				
	Four hole panel mounting	EG	●	●	
	Four hole panel mounting, protection IP 66				
	Panel mounting using larger escutcheon plate and handle	KN1	●	●	
	Four hole panel mounting				
	Four hole panel mounting, protection IP 66	KD1	●	●	
	Panel mounting with heavy duty stop and metal shaft				
	Four hole panel mounting	EC	●	●	
	Mounting plate, escutcheon plate and handle of size S1				
	Four hole panel mounting	ED	●	●	
	Mounting plate, escutcheon plate and handle of size S1 and 6 mm square metal shaft				
	Panel mounting with protective cover	EC	●	●	
	Four hole panel mounting				
	Protection front IP 40 rear IP 42	ED	●	●	
	Four hole panel mounting				
	Protection front IP 65 rear IP 42	ED	●	●	
	Four hole panel mounting				



## Mounting

## A, AD Switches

Single Hole Mounting 40 mm	<b>Code</b>	A11 AD11 AD12	A14	A11C A14C
----------------------------	-------------	---------------------	-----	--------------

	<p>Single hole mounting</p> <p>Without escutcheon plate</p>	EL1	●	●	
	<p>With square escutcheon plate</p>	EL2	●	●	
	<p>With rectangular escutcheon plate</p>	EL4	●	●	

## Base Mounting

	<p>Base mounting</p> <p>Base mounting - four hole</p>	VE	●	●	●
	<p>Snap-on base mounting for track EN 60715</p>	VE1	●	●	

# Handles

Type	Color	Code	Size	
			S1	S2

Type	Color	Code	Size	
			S1	S2

<p>R-Handle</p> 	black red white electro-gray	G001 G002 G003 G007	● ● ● ● ● ● ● ●
<p>F-Handle</p> 	black red white electro-gray	G221 G222 G223 G227	● ● ● ● ● ● ● ●
<p>S-Handle</p> 	black red white electro-gray	G301 G302 G303 G307	● — ● — ● — ● —
<p>P-Handle</p> 	black red white electro-gray	G211 G212 G213 G217	● ● ● ● ● ● ● ●
<p>O-Handle</p> 	black red white electro-gray	G321 G322 G323 G327	● — ● — ● — ● —

<p>I-Handle</p> 	black red white electro-gray	G251 G252 G253 G257	● ● ● ● ● ● ● ●
<p>B-Handle</p> 	black red white electro-gray	G521 G522 G523 G527	● — ● — ● — ● —
<p>L-Handle</p> 	black red white electro-gray	G501 G502 G503 G507	● — ● — ● — ● —
<p>K-Handle</p> 	black red white electro-gray	G411 G412 G413 G417	● ● ● ● ● ● ● ●



# Escutcheon Plates

## 60° switching

F707	F087	F088	F089	F133	F197	F198	SYNCHROSCOPE	F243	F247	F263	F268	F310	F311	HUVUDBRYTARE	HUVUDBRYTARE	F352	F367
F379	F380	F470	F754	F072	F163	F164	F192	F193	F196	F230	F231	F234	F244	F257	F262	F264	F282
F288	F291	F313	F382	F441	F705	F721	F722	F750	F757	F758	F075	F076	F098	F220	F223	F356	F357
F377	F723	F071	F073	F080	F081	F085	F086	F090	F091	F092	F093	F094	F104	F194	F235	F237	F239
F240	F241	F249	F260	F269	F274	F281	F290	F292	F312	F314	F315	F316	F324	F331	F344	F354	F358
F359	F364	F370	F371	F373	F381	F385	F442	F444	F469	F732	F735	F759	F077	F100	F101	F102	F309
F342	F343	F361	F362	F363	F365	F366	F078	F191	F325	F326	F720	F074	F082	F096	F097	F195	F724
F256	F079	F083	F084	F095	F099	F185	F190	F199	F233	F236	F238	F242	F283	F725	F730	F731	F736
F737																	

## 90° switching

F056	F063	F068	F134	F201	F251	F252	F346	F456	F058	F065	F069	F177	F178	F182	F208	F253	F254
F340	F360	F378	F458	F443	F700	F743	F057	F061	F064	F067	F171	F181	F205	F207	F209	F320	F349
F437	F445	F715	F719	F059	F060	F062	F066	F170	F172	F173	F174	F175	F176	F179	F180	F186	F188
F202	F204	F206	F250	F265	F266	F286	F318	F327	F338	F339	F425	F716	F717	F718	F726	F733	F751
F755	F756																

## Miscellaneous

F119	F130	F122	F126	F125	F129	F225	F248	F246	F261	F341	F345	F287	F123	F127	F145	F146	F148						
F706	F707	F245	F120	F124	F128	F131	F121	F132	F749									F990	F991	F801	F802	F803	F804
F805	F806	F807	F808	F809	F810	F811	F812	F813	F814	F815	F816	F817	F818	F819	F820	F821	F822						
F823	F824	F825	F826	F827	F828	F829	F830	F831	F832	F833	F834	F835	F837	F838	F839 <sup>1</sup>	F840 <sup>2</sup>	F841 <sup>3</sup>						

<sup>1</sup>INTERRUPTEUR PRINCIPAL, OUVERTURE EN POSITION 0 <sup>2</sup>INTERRUPTORE GENERALE, APRIRE SOLO CON MANIGLIA SU 0  
<sup>3</sup>INTERRUPTOR PRINCIPAL, ABRIR ARMARIO SOLO EN POS. "0"













Selection Data	A11 A11C	AD11 AD11C	AD12 AD12C	A14 A14C
----------------	-------------	---------------	---------------	-------------

<b>Rated Utilization Category</b>		IEC 60947-3 VDE 0660 part 107							
AC-2	Slip ring motor starting, reversing and plugging, star-delta starting	3 phase	220 V-240 V	kW	4	–	–	5,5	
		3 pole	380 V-440 V		7,5	–	–	11	
			500 V		10	–	–	15	
			660 V-690 V		10	–	–	13	
AC-3	Direct-on-line starting, star-delta starting A11, A14	3 phase	220 V-240 V	kW	3	–	–	4	
		3 pole	380 V-440 V		5,5	–	–	7,5	
			500 V		5,5	–	–	7,5	
			660 V-690 V	5,5	–	–	7,5		
			1 phase	110 V	kW	0,6	–	–	1,5
			2 pole	220 V-240 V		2,2	–	–	3
		380 V-440 V	3	–	–	3,7			
AC-4	Direct-on-line starting, reversing, plugging and inching	3 phase	220 V-240 V	kW	0,55	–	–	1	
		3 pole	380 V-440 V		1,5	–	–	2,2	
			500 V		1,5	–	–	2,5	
			660 V-690 V	1,5	–	–	2,5		
			1 phase	110 V	kW	0,15	–	–	0,2
			2 pole	220 V-240 V		0,25	–	–	0,5
		380 V-440 V	0,55	–	–	0,8			
AC-23A	Frequent switching of motors or other high inductive loads	3 phase	220 V-240 V	kW	3,7	–	–	5,5	
		3 pole	380 V-440 V		7,5	–	–	11	
			500 V		7,5	–	–	11	
			660 V-690 V	7,5	–	–	11		
			1 phase	110 V	kW	0,75	–	–	1,5
			2 pole	220 V-240 V		2,2	–	–	3
		380 V-440 V	3,7	–	–	5,5			
<b>Ratings</b>		UL/Canada							
Standard motor load DOL-Rating (similar AC-3)			120 V	HP	1	–	–	1,5	
		3 phase	240 V		1	–	–	3	
		3 pole	480 V		1	–	–	7,5	
			600 V	1	–	–	10		
			120 V	HP	0,5	–	–	0,75	
		1 phase	240 V		1	–	–	1,5	
2 pole	277 V	1	–		–	2			
	480 V	1	–	–	3				
	600 V	1	–	–	5				
Heavy motor load <sup>1</sup> Reversing-Rating (similar AC-4)			120 V	HP	–	–	–	1	
		3 phase	240 V		–	–	–	2	
		3 pole	480 V-600 V		–	–	–	5	
			120 V	HP	–	–	–	0,33	
		1 phase	240 V		–	–	–	0,75	
		2 pole	277 V		–	–	–	0,75	
<b>Max. Permissible Wire Gage</b> - Use copper wire only									
Single-core or stranded wire				mm <sup>2</sup>	2,5	2,5	2,5	4	
				AWG	12	12	12	10	
Flexible wire				mm <sup>2</sup>	2,5	2,5	2,5	2,5	
(sleeving in accordance with DIN 46228)					(2,5)	(2,5)	(2,5)	(2,5)	
Flexible AWG wires (without sleeve)				AWG	14	14	14	12	

<sup>1</sup>Reversing-Rating is not part of the existing UL and Canada approvals.

## International Standards and Approvals

Country	Authority	Mark or Standard	A11	AD11	AD12	A14
USA/Canada	Underwriters Laboratories			●	●	
			●			●
Switzerland	Schweizerischer Elektrotechnischer Verein		+	+	+	+
Denmark	Danmarks Elektriske Materiekkontrol		+	+	+	+
Norway	Norges Elektriske Materiekkontroll		+	+	+	+
Sweden	Svenska Elektriska Materiekkontrollanstalten		+	+	+	+
Finland	Sähkötar-kastuskeskus		+	+	+	+
Austria	Österreichischer Verband für Elektrotechnik		+	+	+	+
Federal Republic of Germany	Verband Deutscher Elektrotechniker	VDE 0660 <sup>2</sup>	+	+	+	+
Great Britain	British Standards Institution	BS EN 60947 <sup>2</sup>	+	+	+	+
Europe		EN 60947 <sup>2</sup>	+	+	+	+
International Electrical Commission (IEC) Recommendation		IEC 60947 <sup>2</sup>	+	+	+	+

● Switch approved

+ Switch conforms to requirements

<sup>1</sup>Approved under the "Component Program" (UL-Recognized Industrial Component). File No. E35541, Guide No. NLRV2 and NLRV8.

<sup>2</sup>Industrial switchgear is not required to bear a symbol but must conform to requirements. By referring to the specific specification on the product the manufacturer implies that these requirements have been met.

<sup>3</sup>Approved under the "Listing-Program". File No. E35541, Guide No. NLRV and NLRV7 resp. File No. E60262, Guide No. NRNT and NRNT7.

**Dimensions**      mm  
                         inch

Escutcheon Plates and Handles	Size	A	B	C	D1ø	D2ø	Escutcheon Plates and Handles	Size	A	B	C	D1ø	D2ø
-------------------------------	------	---	---	---	-----	-----	-------------------------------	------	---	---	---	-----	-----

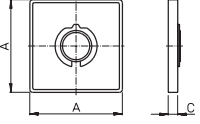
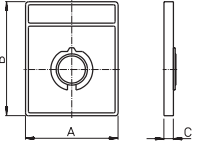
PE-Escutcheon Plate							PR-Escutcheon Plate						
	<b>S1</b>	64		7,4				<b>S1</b>	64	78,8	7,4		
	<b>S2</b>	2,52		.29					2,52	3,10	.29		
		88		8,5									
		3,46		.34									

Dimensions for the E, EF, ER, ERF, EG, EGF, KN1, KD1, EC, ED, VE and VE1 escutcheon plates.  
Dimensions of the escutcheon plates used for other mounting, refer to page 27.

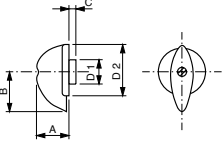
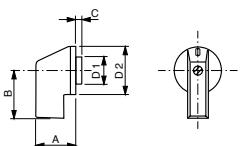
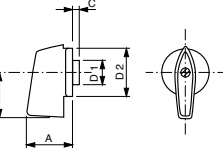
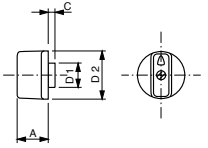
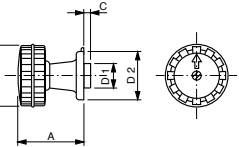
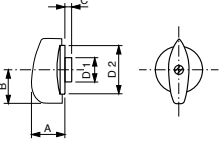
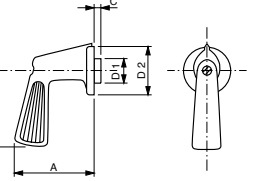
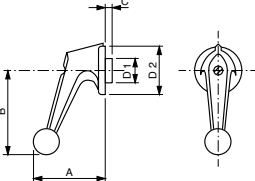
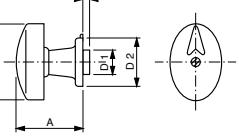
<b>R-Handle</b> 	<b>S1</b> 23 0.91 <b>S2</b> 30 1.18	31,5 1.24 42 1.65	5 .20 5 .20	18,2 .72 25,4 1.00	36 1.42 50,0 1.97	<b>I-Handle</b> 	<b>S1</b> 27 1.06	31,8 1.25	2,5 .10	18,2 .72	36 1.42
<b>F-Handle</b> 	<b>S1</b> 34 1.34 <b>S2</b> 44,7 1.76	34 1.34 45 1.77	5 .20 5 .20	18,2 .72 25,4 1.00	36 1.42 50 1.97	<b>B-Handle</b> 	<b>S1</b> 23 .91	5 .20	18,2 .72	36 1.42	
<b>S-Handle</b> 	<b>S1</b> 50 1.97	45 1.77	5 .20	18,2 .72	36 1.42	<b>L-Handle</b> 	<b>S1</b> 24 .95	24,1 .95	5 .20	18,2 .72	36 1.42
<b>P-Handle</b> 	<b>S1</b> 58 2.28 <b>S2</b> 70 2.76	57,5 2.26 68 2.68	5 .20 5 .20	18,2 .72 25,4 1.00	36 1.42 50 1.97	<b>K-Handle</b> 	<b>S1</b> 54 2.13 <b>S2</b> 55 2.17	64 2.52 71 2.80	5 .20 5 .20	18,2 .72 25,4 1.00	36 1.42 50 1.97
<b>O-Handle</b> 	<b>S1</b> 50 1.97	56 2.2	5 .20	18,2 .72	36 1.42						

**Dimensions**      mm  
                              inch

<b>Four Hole Panel Mounting</b>	<b>A11</b>		
	<b>AD11</b>		<b>A11C</b>
	<b>AD12</b>	<b>A14</b>	<b>A14C</b>

<b>E, ER</b>		<b>A</b>	64 2.52	64 2.52	88 3.46
		<b>B</b>	48 1.89	48 1.89	68 2.68
		<b>C</b>	4 .16	4 .16	5.5 .22
		<b>D1</b>	5 .20	5 .20	6 .24
		<b>D2</b>	10-15 .39-.59	10-15 .39-.59	13-17 .51-.67
		<b>D3</b>	60 2.36	65 2.56	84 3.31

<b>EF, ERF</b>		<b>A</b>	64 2.52	64 2.52	88 3.46
		<b>B</b>	48 1.89	48 1.89	68 2.68
		<b>C</b>	4 .16	4 .16	5.5 .22
		<b>D1</b>	5 .20	5 .20	6 .24
		<b>D2</b>	19-22 .75-.87	19-22 .75-.87	26-30 1.02-1.18
		<b>D3</b>	60 2.36	65 2.56	84 3.31

<b>EG, EGF</b>		<b>A</b>	88 3.46	88 3.46	-
		<b>B</b>	68 2.68	68 2.68	-
		<b>C</b>	5.5 .22	5.5 .22	-
		<b>D1</b>	6 .24	6 .24	-
		<b>D2</b> EG	13-17 .51-.67	13-17 .51-.67	-
		<b>D2</b> EGF	26-30 1.02-1.18	26-30 1.02-1.18	-
		<b>D3</b>	60 2.36	65 2.56	-

<b>KN1, KD1</b>		<b>A</b>	60 2.36	60 2.36	
		<b>B</b>	48 1.89	48 1.89	
		<b>C</b>	4 .16	4 .16	
		<b>D1</b>	5 .20	5 .20	
		<b>D2</b>	10-15 .39-.59	10-15 .39-.59	
		<b>D3</b>	60 2.36	65 2.56	

<b>EC, ED</b>		<b>A</b>	88 3.46	88 3.46	
		<b>B</b>	68 2.68	68 2.68	
		<b>C</b> EC	5.5 .22	5.5 .22	
		<b>C</b> ED	7.5 .30	7.5 .30	
		<b>D1</b>	6 .24	6 .24	
		<b>D2</b> EC	13-17 .51-.67	13-17 .51-.67	
		<b>D2</b> ED	28-33 1.10-1.30	28-33 1.10-1.30	

**Dimensions**      mm  
                              inch

<b>Single Hole Mounting 40 mm</b>	<b>A11 AD11 AD12    A14</b>
-----------------------------------	-------------------------------------

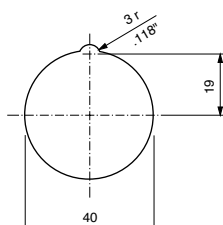
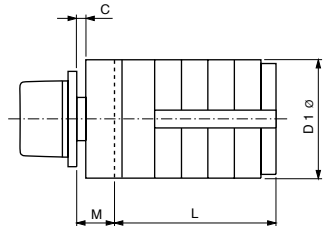
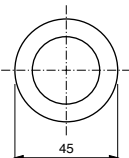
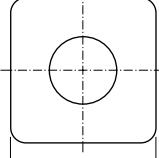
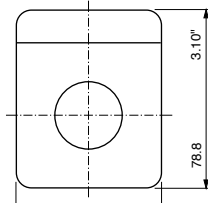
<b>EL1</b>	<b>EL2</b>	<b>EL4</b>								
										
				<table border="1"> <tr> <td>D1</td> <td>60 2.36</td> <td>65 2.56</td> </tr> <tr> <td>C</td> <td>1-6.3 .04-.25</td> <td>1-6.3 .04-.25</td> </tr> </table>	D1	60 2.36	65 2.56	C	1-6.3 .04-.25	1-6.3 .04-.25
D1	60 2.36	65 2.56								
C	1-6.3 .04-.25	1-6.3 .04-.25								

<b>Base Mounting</b>	<b>A11 AD11 AD12    A14    A11C A14C</b>
----------------------	--

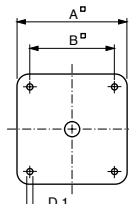
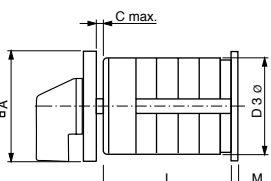
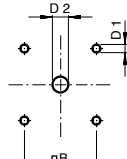
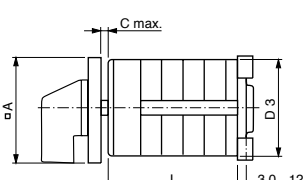
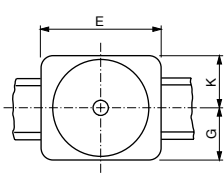
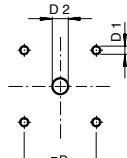
<b>VE</b>				<b>A</b>	64 2.52	64 2.52	88 3.46
				<b>B</b>	48 1.89	48 1.89	68 2.68
				<b>C</b>	13.5 .53	13.5 .53	16 .63
				<b>D1</b>	5 .20	5 .20	6 .24
				<b>D2</b>	10-15 .39-.59	10-15 .39-.59	13-17 .51-.67
				<b>D3</b>	60 2.36	65 2.56	84 3.31
				<b>D4</b>	4.1 .16	4.1 .16	5.4 .21
				<b>E</b>	70 2.76	70 2.76	-
				<b>G</b>	30 1.18	30 1.18	-
				<b>K</b>	30 1.18	30 1.18	-
<b>VE1</b>							

<b>Length L</b>	<b>A11 AD11 AD12    A14</b>	<b>Length L</b>	<b>A11 AD11 AD12    A14</b>	<b>Additional Length M<sup>1</sup></b>	<b>A11 AD11 AD12    A14</b>
-----------------	-------------------------------------	-----------------	-------------------------------------	--	-------------------------------------

<b>Mounting E</b>	<b>Mounting EC and ED</b>	<b>Mounting + switch with latching mechanism size S2</b>
-------------------	-------------------------------	--

<b>No. of stages</b>		<b>No. of stages</b>	<b>EC, ED</b>	<b>EC, ED</b>	<b>ER/ERF</b>	6.5 .26	6.5 .26
1	42.5 1.67	42.5 1.67	41.5 1.63	47.2 1.86	EG/EGF	0.5 .02	0.5 .02
2	55.2 2.17	55.2 2.17	54.2 2.13	59.9 2.36	KN1/KD1	7 .28	7 .28
3	67.9 2.67	67.9 2.67	66.9 2.63	72.6 2.86	VE	5 .20	5 .20
4	80.6 3.17	80.6 3.17	79.6 3.13	85.3 3.36	EL1	11 .43	11 .43
5	93.3 3.67	93.3 3.67	92.3 3.63	98 3.86	EL2	11 .43	11 .43
6	106 4.17	106 4.17	105 4.13	110.7 4.36	EL4	11 .43	11 .43
7	118.7 4.67	118.7 4.67	117.7 4.63	123.4 4.86	<b>A11C/A14C</b>	8.2 .32	8.2 .32
8	131.4 5.17	131.4 5.17	130.4 5.13	136.1 5.36			
9	144.1 5.67	144.1 5.67	143.1 5.63	148.8 5.86			
10	156.8 6.17	156.8 6.17	155.8 6.13	161.5 6.36			
11	169.5 6.67	169.5 6.67	168.5 6.63	174.2 6.86			
12	182.2 7.17	182.2 7.17	181.2 7.13	186.9 7.36			

<sup>1</sup>Additional length plus length shown in the E mounting table = overall length

---

# The Range of “Blue Line” Switchgear

Technical literature covering the following products is available on request.

	Catalog Number
<b>Main Switches and Main Switches with Emergency Function 16 A-315 A</b> <b>Maintenance Switches 20 A-315 A</b> <b>Switch Disconnectors 20 A-315 A</b> According to IEC 60947-3, EN 60947-3, VDE 0660 part 107, IEC 60204, EN 60204 and VDE 0113	<b>500</b>
<b>CL Switches 10 A-20 A</b> <b>C, CA and CAD Switches 10 A-315 A and L Switches 350 A-2400 A</b> C, CA and CAD switches are designed for universal application. They are recommended for instrument, isolator, double-throw and motor control. L switches are designed for load and off-load applications. They are used to switch resistive or low inductive loads.	<b>100</b>
<b>Optional Extras and Enclosures</b> The complete product line, a large number of optional extras is available, including door interlocks, push-pull devices, cylinder and padlock attachments, control and indicator devices, AC motor drives, as well as enclosures, both insulated and metal.	<b>101</b>
<b>A and AD Switches 6 A-25 A</b> A and AD switches have 4 contacts in each switching stage. These switches provide an extensive range of switch functions and require a minimum mounting depth. Up to 36 switching positions are possible, with availability of 48 contacts per 12 stage switch column.	<b>110</b>
<b>CG, CH and CHR Switches 10 A-25 A</b> Ultra compact CG, CH and CHR switches are ideally suited for control and instrumentation applications. Switch terminals are “finger-proof” and conveniently accessible for wiring and are delivered open. All CG4 switches offer specially designed gold plated contacts or H-bridges with “cross-wire” contact systems, which facilitates their use in electronic circuitry and chemically aggressive environments.	<b>120</b>
<b>DH, DHR, DK and DKR Switches 6 A-16 A</b> DH, DHR, DK and DKR switches incorporate unique corrosion resistant contacts that permit operation on system voltage as low as 1 V. They have fully enclosed and protected contacts which can be operated either by rotary and/or lateral handle movement. D switches are used in calibration and semiconductor circuits. They are also used for relay and contactor control.	<b>130</b>
<b>X Switches 80 A-630 A</b> X switches can be applied for load, tap and gang switching duties. They incorporate 6 contacts in each switching stage. Their compact design provides a minimum length dimension for mounting purposes.	<b>140</b>
<b>KG Switches 20 A-315 A and KH and KHR Switches 16 A-80 A</b> KG, KH and KHR switches are excellent circuit interruptors. They have high through fault and fault making capacities and are especially designed for use as isolators and safety switches for machine tools, distribution panels and switchboards. KG ON/OFF switches offer unusually high dimensioned air and creepage distances between terminals which are designed for time saving “straight-line” wiring. ON/OFF switches are available with up to 8 poles and double-throw switches are available with up to 4 poles.	<b>150</b>
<b>Contactors 16 A-115 A and Motor Starters 1,1 kW-55 kW</b> These include control relays, motor contactors, two and four pole output contactors, heating contactors, thermal overload relays.	<b>200</b>
<b>Push Buttons and Pilot Lights, 22,5 mm Ø</b> A complete range of state-of-the-art push buttons and pilot lights represent an ideal combination of functional security and economical efficiency in a modular design.	<b>302</b>

## SALES AND SERVICE ORGANIZATION

---

### Australia

**Kraus & Naimer Pty. Ltd.**  
379 Liverpool Road, ASHFIELD, N.S.W. 2131  
Tel: +61 2 9797-7333, Fax: 0092  
salesaus@krausnaimer.com

### Austria

**Kraus & Naimer GmbH**  
Schumanngasse 35, Postfach 431  
A-1181 WIEN  
Tel: +43 1 404 06-0, Fax: 404 06-190  
aso@krausnaimer.com

### Belgium, Luxembourg

**Kraus & Naimer B.V.**  
Ikaros Business Park  
Ikaroslaan 2  
B-1930 ZAVENTHEM  
Tel: +32 2 757-0141, Fax: 1640  
sales.be@krausnaimer.com

### Brazil

**Central and South America**  
**Kraus & Naimer Ind. Com. Ltda.**  
Rua Santa Monica, 1061  
Parque Industrial San Jose  
06715-865 Cotia - SP  
Tel: +55 11 2198-1288, Fax: 1251  
knbrasil@krausnaimer.com.br

### Canada

**Kraus & Naimer Ltd.**  
219 Connie Crescent, Unit: 13A  
CONCORD, Ontario, L4K 1L4  
Tel: +1 905 738-1666, Fax: 9327  
salescan@krausnaimer.com

### Cyprus

**ELECTROMATIC CONSTRUCTIONS LTD.**  
72, Evagoras Pallikarides Str., CY-2235 LATSIA-Nicosia  
P. O. Box 12630, CY-2251 LATSIA-Nicosia  
Tel: +357 2 48 41 41, Fax: 48 57 47

### Czech Republic

**OBZOR, výrobní družstvo Zlín**  
Na Slanici 378  
CZ-76413 ZLÍN  
Tel: +420 57 7195-111/-153 (Techn. Supp.)  
Fax: +420 57 7195-152/-138  
ots@obzor.cz

### Denmark

**THIIM A/S**  
Transformervej 31  
DK-2730 HERLEV  
Tel: +45 4485 8000, Fax: 8005  
thiim@thiim.com

### Finland

**Kraus & Naimer Oy**  
Karitie 7  
FIN-01530 VANTAA  
Tel: +358 9 825-424-0, Fax: 424-10  
myynti@krausnaimer.com

### France

**Kraus & Naimer s.a.s.**  
33, rue Bobillot  
F-75013 PARIS  
Tél: +33 1 58 40 80 80, Fax: 45 80 91 19  
ventes@krausnaimer.com

### Germany

**Kraus & Naimer GmbH**  
Wikingerstraße 20-28, D-76189 KARLSRUHE  
Postfach 10 01 24, D-76231 KARLSRUHE  
Tel: +49 721 59 88-0, Fax: 59 28 28  
sales.ger@krausnaimer.com

### Great Britain

**Kraus & Naimer Ltd.**  
115 London Road  
NEWBURY/BERKSHIRE RG14 2AH  
Tel: +44 1635 262626, Fax: 37807  
sales-uk@krausnaimer.com

### Greece

**KALAMARAKIS-SAPOUNAS S. A.**  
Ionias & Neromilou Str., P. O. Box 46566  
GR-13671 ACHARNES/ATHENS  
Tel: +30 2 10 240-6000-6, Fax: 240-6007  
kalamarakis.sapounas@ksa.gr

### Hungary

**GANZ, Schalter- u. Gerätefabrik**  
X. Kőbányai út 41/c, Postfach 87  
H-1475 BUDAPEST  
Tel: +36 1 261-5479, Fax: 4685  
ganzkk@ganzkk.hu

### Iceland

**BRAEDURNIR ORMSSON EHF**  
Lágmúli 6-8, P. O. Box 8670  
REYKJAVIK  
Tel: +354 530-28 00, Fax: 28 10  
skuli@ormsson.is

### India

Liaison Office, **Kraus & Naimer Pte. Ltd.**  
10B, 1st Floor, Infinity,  
Ashar Commercial Complex, Gladly Alwares Road  
Off Pokhran Road no. 2,  
THANE (W) 400 610  
Tel: +91 22 66716451, Fax: 66716451  
india@krausnaimer.com

### Republic of Ireland

**Kraus & Naimer Ltd.**  
Bay 145, Shannon Free Zone  
SHANNON, Co. Clare  
Tel: +353 61 704700, Fax: 471084  
sales-ie@krausnaimer.com

### Italy

**Kraus & Naimer s.r.l.**  
Via Terracini, 9  
I-24047 TREVIGLIO (BG)  
Tel: +39 0363-30 11 12, Fax: 30 21 13  
sales-ita@krausnaimer.com

### Japan

**Kraus & Naimer Ltd.**  
Yoshiwada Building 2F  
1-11-6 Hamamatsucho  
Minato-Ku, TOKYO 105-0013  
Tel: +81 3 3436-6151, Fax: 6325  
sales-jpn@krausnaimer.com

### Mexico

JC Ingeniería y Control, SA de CV.  
Ángel Gaviño 30,  
C. Satélite, C. Medicos,  
Naucalpan Edo. de Mexico, C.P. 53100  
Tel. (+52 55) 55 62 75 77, Fax. 55 62 04 34  
ventas@jcingenieriacontrol.com

### Middle East - UAE

Branch Office, **Kraus & Naimer Pte. Ltd.**  
SAIF Zone, P. O. Box 121607,  
Sharjah, UAE  
Tel: +971 6 557 8886  
Fax: +971 6 557 8088  
uae@krausnaimer.com

### Netherlands

**Kraus & Naimer B.V.**  
Wegtersweg 38-40, Postbus 199  
NL-7556 BR HENGEL0 (Ov.)  
Tel: +31 74 291-9441, Fax: 8380  
sales.nl@krausnaimer.com

### New Zealand

**Kraus & Naimer Ltd.**  
42 Miramar Avenue, WELLINGTON 6022  
P. O. Box 15-009, WELLINGTON 6243  
Tel: +64 4 380-9888, Fax: 9877  
sales-nz@krausnaimer.com

### Norway

**Kraus & Naimer AS**  
Hjalmar Brantings vei 8, P. O. Box 21, Økern  
N-0508 OSLO  
Tel: +47 22 64 44 20, Fax: 65 39 49  
ordre.no@krausnaimer.com

### Poland

ASTAT sp. z o.o.  
ul. Dąbrowskiego 461  
PL-60451 POZNAN  
Tel: +48 61 848-8871/72, Fax: 8276  
info@astat.com.pl

### Portugal

**ELECTRICOL-DAMAS, FERREIRA & DAMASCENO, LDA.**  
Apartado 1063, S. Ant. Cavaleiros  
P-2670 LOURES  
Tel: +351 21 989-8939, Fax: 988-6464  
Im.emertex@electricol.pt

### Singapore

**Kraus & Naimer Pte. Ltd.**  
Blk 115A, Commonwealth Drive  
#03-17/23  
SINGAPORE 149 596  
Tel: +65 6473-8166, Fax: 8643  
sgp@krausnaimer.com

### Slovenia

**SCHRACK Technik d.o.o.**  
Pameče 175  
SI-2380 Slovenj Gradec  
Tel: +386 2 883 92 00, Fax: +386 2 884 34 71  
m.abeln@schrack.si

### Republic of South Africa

**Kraus & Naimer Pty. Ltd.**  
7 Village Crescent, Linbro Village  
Linbro Business Park, SANDTON 2065  
P. O. Box 511, KELVIN 2054  
Tel: +27 11 608-6060, Fax: 608-2874  
salesZAF@krausnaimer.com

### Spain

**HAZEMEYER HES. S.L.**  
Pol. Ind. Gaserans  
Sector 3, Parcela 7B  
17451 SANT FELIU DE BUIXALLEU (GIRONA)  
Tel: +34 972 87-4450, Fax: 87-4402  
hazemeyer@grupo-hes.net

### Sweden

**Kraus & Naimer AB**  
Dr. Widerströms Gata 11, FRUÅNGEN  
Box 42097, S-126 14 STOCKHOLM  
Tel: +46 8 97 00 80, Fax: 97 87 33  
order.se@krausnaimer.com

### Switzerland

**AWAG Elektrotechnik AG**  
Sandbühlstraße 2, Postfach  
CH-8604 VOLKETSCHWIL  
Tel: +41 44 908 19 19, Fax: 19 99  
info@awag.ch, www.awag.ch

### Turkey

**KARDEŞ ELEKTRİK SANAYİ VE TİCARET ANONİM ŞİRKETİ**  
Beşyol, Eski Londra Asfaltı-6  
TR-34295 İSTANBUL-Sefaköy  
Tel: +90 212 624-9204, Fax: 592-4810  
info@unalkardes.com.tr

### USA

**Kraus & Naimer Inc.**  
760 New Brunswick Road  
SOMERSET, NJ 08873  
Tel: +1 732 560-1240, Fax: 8823  
salesusa@krausnaimer.com



Kraus & Naimer

BLUE LINE switchgear



YOUR SALES CONTACT